

NT NOTICE TO SHIPPING No. N-1-2020



Vessel
Requirements

January 1, 2020

NT NOTICE TO SHIPPING No. N-1-2020

To: Shipping Agents, Owners and Operators

Subject: Vessel Requirements

1. Effective Date and Cancellation

This Notice is effective on the date of issue and cancels NT Notice to Shipping No. N-1-2019. A revised Notice will be issued in January of each year or when otherwise required. This revision includes the following changes:

(1) Items (a), (b), (c) and (d) were incorporated in Section 5 (*Relevant Information for Canal Customers*), on p. 4.

2. Purpose and Scope

The purpose of this document is to inform the shipping community of the procedures and amplifications necessary to implement the Maritime Regulations for the Operation of the Panama Canal (MROPC). **Please be advised that non-compliance with Panama Canal rules and regulations may subject vessels to unnecessary delays or denial of transit.** The Panama Canal Authority (ACP) may order deviations from these rules if special circumstances so warrant. Please refer to the Table of Contents on pages 6 through 8.

This Notice contains new Vice Presidency, sections, units and position names, as well as other organizational changes related to the recent reorganization of the Panama Canal Authority.

3. Organization and Responsibility

The *Vice Presidency for Transit Business* (272-4500, fax: 272-3892), under the Vice President for Transit Business, is the organizational department of the Panama Canal Authority responsible for the control of maritime traffic through the Canal and its terminal ports, and through which all ACP services to shipping are handled. Following is a summary of the Vice Presidency for Transit Business' units which, due to their functions, often require contact with agents, operators and owners:

a. The *Transit Operations Division* (272-4218), headed by the Transit Operations Division manager, is responsible for the immediate direction of daily maritime operations,

PANAMA CANAL AUTHORITY (ACP)
Vice Presidency for Transit Business
Bldg. 729, Balboa-Ancon
Panama, Panama
www.pancanal.com

emergency response and recovery, supervision and enforcement of rules and regulations governing the navigation of the Canal, approval of new construction compliance with chocks and bits, boarding facilities, wheelhouse design features and visibility requirements, and for ensuring that vessels arriving for transit are properly equipped. Additionally, the unit is responsible for matters involving the safety aspects of vessel traffic flow and control, vessel material conditions and inspections, hazardous cargo, Canal physical conditions, and emergency response for fires or oil/chemical spills. The responsibilities of the Transit Operations Division executive manager are exercised through the Canal port captain on duty.

b. The *Marine Traffic Control Unit* (272-4201, fax: 272-3976, ETA@pancanal.com), headed by the Traffic Management Unit manager, is responsible for processing ETA information, preparation of the daily transit schedule, monitoring and coordinating all vessel movements within Canal operating areas, and administering the Panama Canal Transit Booking System, gathering information for the Ship Data Bank, and generating billing invoices for transits and related services.

c. The Admeasurement Unit (272 4567, fax: 272 5514, OPTC-A@Pancanal.com), headed by the Admeasurement Unit manager, is responsible for ascertaining the correct Panama Canal tonnage of vessels transiting the Canal, ascertaining and auditing the Total TEU Allowance (TTA) on full container vessels and Number of TEUs Transported (NTT) on other vessels with on-deck carrying capacity, maximum number of berth on passenger vessels and the maximum displacement on warships, dredges and floating dry-docks, boarding and clearing of vessels for medical surveillance, general ship inspections.

d. The *Board of Inspectors* (272-3403, fax: 272-3548), headed by the Board of Inspectors chairman, is responsible for the official inquiry and examination into the circumstances surrounding marine accidents which occur in Canal waters involving Authority personnel and/or equipment. In addition, this office is responsible for the certification of marine credentials of Authority employees.

Finally, vessel transits are a joint effort. In addition to the responsibilities of the units outlined above, vessel owners, operators, agents, officers and crews are responsible for compliance with Canal rules and regulations. Cooperation of all concerned parties is necessary to ensure a safe and efficient transit.

4. Communication Channels

Direct communication with the Vice Presidency for Transit Business' units may be established by the following means:

- a. MAIL: AUTORIDAD DEL CANAL DE PANAMA (ACP)
(Name, position and title)
ACP-OP
P.O. Box 526725
Miami FL 33152-6725
- b. FACSIMILE: (Name of Unit)

(Fax numbers listed on the previous page.)

- c. TELEPHONE: (Telephone numbers listed on the previous page.)
- d. INTERNATIONAL COUNTRY CODE – For fax and telephone: 507
- e. TRAFFIC MANAGEMENT UNIT – Via e-mail: ETA@pancanal.com
- f. RADIO PRATIQUE MESSAGES – Via e-mail: NTOT-ARP@pancanal.com
- g. DRAWING SUBMITALS – Via e-mail: PlanApproval@pancanal.com or printed form directly to:

Courier mail: AUTORIDAD DEL CANAL DE PANAMA
División de Operaciones de Tránsito (NTO)
Edificio 910, La Boca
Balboa, Panama
Republic of Panama
(Telephones: 272-4191/4296)

Regular mail: AUTORIDAD DEL CANAL DE PANAMA
División de Operaciones de Tránsito (NTO)
Balboa, Panama
Republic of Panama

The drawings submitted via e-mail or disk should be saved preferably in PDF or TIFF file format, or in a file format compatible with AUTOCAD. All drawing and letter files may be compressed together into one zip/7z/rar file. Files exceeding 10MB must not be included within compressed files, instead they must be sent in their original format

h. For admeasurement purposes the drawings shall be submitted to: ACPShipplans@pancanal.com at least 96 hours prior to arrival at Panama Canal Waters in PDF or AUTOCAD formats only, in one single plan (not in parts that have to be pieced back together.)

5. Relevant Information for Canal Customers

a. Deck Cooling During Transit

The ACP will require transiting crude oil tankers, product carriers, and chemical tankers carrying cargoes with flashpoints of less than 18°C, to cool their main decks with water by means of the on-deck water sprinkler system, or any other means available. For further information, please direct inquires to cargoinfo@pancanal.com

b. Revised Version of Form 4510 “Container Summary for All Vessels”

The ACP has revised Form 4510 (NTOT-A) “Container Summary for All Vessels” to reflect the type of cargo carried above and below deck on vessels transiting the Panama Canal.

The revised version of Form 4510 may be downloaded from the following link:
<http://www.pancanal.com/eng/op/forms.html>

c. Use of Mooring Tails (pennants) With High-Modulus Polyethylene (HMPE) Lines

The ACP requires the attachment and use of mooring tales (pennants) when the vessel is providing HMPE lines for mooring and lockage operations within the Panama Canal.

Tails must be properly matched and connected to the specific HMPE line with which they are going to work. The size, material and length of the mooring tails (pennants) shall comply with the requirements by the HMPE line manufacturer.

d. Modification to BAPLIE File Requirement for Full Container Vessels

The deadline for submitting the BAPLIE file for transiting full container vessels has been extended to

0900 hours of the day following the transit date. In addition, if the day following the transit date falls on a weekend or an official holiday, the BAPLIE file and a Container Summary form shall be received no later than 0900 hours of the first business day following the transit date.

The procedures regarding how to submit the BAPLIE extension request in VUMPA may be obtained through customerservice@pancanal.com

Ilya R. Espino de Marotta
Vice President for Transit Business

VESSEL REQUIREMENTS

TABLE OF CONTENTS

	PAGE
1. Definitions	9
2. Size and Draft Limitations of Vessels	10
a. Vessels Transiting the Panamax Locks	10
b. Vessels Transiting the <i>Neopanamax</i> Locks	12
c. Other Draft Considerations	14
d. Maximum Width	16
e. Protrusions.....	16
f. Maximum Height	17
g. Release from Liability	17
h. Approval of Plans.....	18
i. Required Documentation for Initial Transit in Electronic Format.....	19
j. Denial of Transit.....	20
k. Vessel Should Be Able to Relay at the Locks.....	21
3. Requirement for Pilot Platforms and Shelters on Certain Vessels	21
4. Navigation Bridge Features Required of Transiting Vessels	23
a. Authority.....	23
b. Wheelhouse	23
c. Bridge Wings	24
d. Normal Conning Positions	24
e. Panama Canal Minimum Visibility Requirements	25
f. Indicators	28
g. Very High Frequency (VHF) Radio	29
h. Whistle Controls	30
i. Steering Light.....	30
j. Bow/Stern Thrusters	30
k. Compass.....	30
l. Course Recorders.....	31
m. Bridge Wing Spotlights	31
n. Radar	31
o. Main Propulsion Systems	32
p. Use of Automatic Identification System (AIS)	32
q. Steering gear	35
5. Requirements for Non-Self-Propelled Vessels	35
6. Vessels Requiring Towing Services	37
7. Deck Load Cargo	37
8. Construction, Number and Location of Chocks and Bitts	39
a. Vessels Transiting the Panamax Locks	39

b. <i>Neopanamax</i> and <i>Panamax Plus</i> Vessels.....	44
<u>9. Mooring Lines, Anchors and Deck Machinery</u>	<u>46</u>
<u>10. Boarding Facilities</u>	<u>47</u>
<u>11. Double Hull Requirements for Oil Tankers</u>	<u>52</u>
<u>12. Admeasurement System for Full Container Vessels</u>	<u>52</u>
<u>13. Deck-Loaded Containers on Ships not Built for Container Carriage</u>	<u>55</u>
a. General.....	55
b. Approval for Transits	55
c. Advance Notice and Inspection	55
<u>14. Unauthorized Modification to the ACP/TOLL BASIS Certificate</u>	<u>56</u>
<u>15. Calculation of PC/UMS Net Tonnage on Passenger Vessels</u>	<u>56</u>
<u>16. Dangerous Cargo Requirements</u>	<u>57</u>
a. General.....	57
b. Test of Equipment on Board.....	57
c. Holding Due to Non-Compliance	57
d. Reporting Dangerous Cargo in Bulk	57
e. Tankers Claiming Cargo Tanks as “Gas Free” or “Inert”	58
f. Reporting Shipments of Direct Reduced Iron	58
g. Precautionary Measures Due to Dangerous Cargo	59
h. Reporting Shipments of Hazardous Wastes	60
i. Reporting Radioactive Cargo.....	61
j. Coverage Requirements for Transiting Vessels Carrying Radioactive Cargo.....	61
k. Advance Notification of Shipments of Fissionable Materials	62
l. Tanker Inspection Program	62
<u>17. Cargo Regulated Under Annex II of MARPOL</u>	<u>63</u>
<u>18. Pre-Arrival Cargo Declarations, Security Inspection and Escort</u>	<u>64</u>
<u>19. Hot Work Performed On Board Vessels</u>	<u>65</u>
<u>20. Manning Requirements</u>	<u>68</u>
<u>21. Additional Pilots Due to Vessel Deficiencies</u>	<u>69</u>
<u>22. Pilot Accommodations On Board Transiting Vessels</u>	<u>70</u>
<u>23. Air Conditioning Systems on Transiting Vessels</u>	<u>70</u>
<u>24. Main Source of Electrical Power</u>	<u>70</u>
<u>25. Emergency Source of Electrical Power</u>	<u>71</u>

<u>26. Sanitary Facilities and Sewage Handling</u>	<u>71</u>
<u>27. Ballast Water Management</u>	<u>71</u>
<u>28. Discharging of Vessel Wastes, and Oily Bilge Water</u>	<u>72</u>
<u>29. Emergency Escape Breathing Devices</u>	<u>73</u>
<u>30. Smoking Prohibition in Canal Waters</u>	<u>74</u>
<u>31. Maneuvering Fuel</u>	<u>74</u>
<u>32. Proper Display of the Panamanian Flag</u>	<u>75</u>
<u>33. Use of Drones in the Panama Canal</u>	<u>76</u>
<u>ANNEX 1 – Panamax Locks Composite Maximum Clearances</u>	<u>77</u>
<u>ANNEX 2 – <i>Neopanamax</i> Locks (Cocoli)</u>	<u>78</u>
<u>ANNEX 3 – <i>Neopanamax</i> Locks (Agua Clara)</u>	<u>79</u>
<u>ANNEX 4 – <i>Neopanamax</i> Locks Clearances Diagram</u>	<u>80</u>

VESSEL REQUIREMENTS

1. Definitions

- a. *Barge*:** A flat-bottomed vessel of full body and heavy construction without installed means of propulsion.
- b. *Commercial Vessel*:** A self-propelled vessel other than a naval, military or other public vessel.
- c. *Dangerous Cargo*:** Any material which is explosive, flammable, radioactive or toxic to humans or the environment.
- d. *Full Container Vessel*:** Vessel specifically designed or converted to transport containers above the upper deck and that has cellular guides permanently affixed in its holds.
- e. *Integrated Tug-Barge Combination*:** A pushing vessel and a non-tank barge pushed ahead rigidly connected to each other to form a composite unit. A composite unit means a pushing vessel rigidly connected by "mechanical means" to a barge being pushed, so they react to the sea and swell as one vessel, and, as such, considered a single power-driven vessel. "Mechanical means" does not include lines, hawsers, wires or chains. To be considered an ITB at the Panama Canal, such vessels must meet all current ACP regulations and requirements for transit and be able to operate in all conditions under which a ship of equivalent size can operate.
- f. *Maximum Allowable Response Time*:** The maximum allowable amount of time that it takes the main propulsion to respond from stop to ahead or from stop to astern, after a telegraph order is received, which must be tested before the transit begins.
- g. *Maximum Authorized Draft*:** Lesser of the maximum authorized transit draft or the maximum tropical freshwater draft by Load Line Certificate.
- h. *Maximum Authorized Transit Draft*:** Deepest point of immersion in TFW of a particular vessel permitted at any time, Gatun Lake level and Canal restrictions permitting.
- i. *Maximum Beam*:** The maximum breadth (width) of the hull between the outside surfaces of the shell plating.
- j. *Maximum Length*:** The distance between the forward and after extremities of a vessel, including the bulbous bow and protrusions (also length overall - LOA)
- k. *Maximum Width*:** The extreme width of a vessel, including protrusions, at its widest point.
- l. *Minimum Full Ahead Speed*:** The ACP has determined that the minimum *full ahead* speed required in order to complete transit in standard times is 8 knots.
- m. *Neopanamax*:** All vessels with dimensions greater than *Panamax* that comply with the size and draft limitations of the new locks; namely, 367.28 meters (1205 feet) in length by 51.25 meters (168.14 feet) in beam by 15.24 meters (50.00 feet), TFW draft.

- n. *Non-Self-Propelled Vessel:*** A vessel which either does not have installed means of propulsion, or has installed means of propulsion which does not function during transit. It is also referred to as dead tow.
- o. *Panama Canal Universal Measurement System (PC/UMS):*** The system based on the Universal Measurement System, 1969, using its parameters for determining the total volume of a vessel with the additional variations established by the Panama Canal Authority.
- p. *Panamax vessels:*** Vessels of 30.48 meters (100 feet) in beam or more that comply with the size and draft limitations of the Panamax locks; namely, 294.13 meters (965 feet) in length by 32.31 meters (106 feet) in beam by 12.04 meters (39.50 feet), TFW draft.
- q. *Panamax Plus vessels:*** All *Panamax* vessels authorized for TFW drafts greater than 12.04 meters (39.50 feet) up to 15.24 meters (50.00 feet) and approved for transit of the new locks.
- r. *Passenger Vessel:*** A vessel that principally transports passengers and runs on fixed published schedules. All the spaces that have been identified and certified for the use or possible use of passengers are to be included in the total volume calculation of the vessel.
- s. *Protrusion:*** Anything that extends beyond any portion of the hull of a vessel, whether it is permanent or temporary, except for the main anchors.
- t. *Published TFW Maximum Draft:*** Deepest point of immersion in Gatun Lake waters as promulgated by the Vice President for Transit Business, taking into account the water level of Gatun Lake and other limitations deemed necessary because of restrictions in the Canal.
- u. *Safe Working Load (SWL):*** The maximum load that can be safely applied to a fitting used for mooring or towing on a vessel, tug or barge, and normally shown on a label plate adjacent to the fitting or marked upon it. The SWL should not exceed 80 percent of the design load.
- v. *TEU:*** International measure standard for a container (20-foot equivalent unit), which is 20' x 8' x 8.5'.
- w. *Tropical Fresh Water (TFW):*** Tropical Fresh Water of Gatun Lake, density 0.9954 tons/m³ at 29.4 °C. (Note: Transition to fresh water frequently alters the trim of large vessels 7.5 to 10 centimeters (0.24 to 0.325 feet) by the head.

2. Size and Draft Limitations of Vessels

a. *Vessels Transiting the Panamax Locks*

(1) Maximum Length

a) The maximum length overall including bulbous bow for commercial or non-commercial vessels acceptable for regular transit of the Panamax locks is 289.6 meters (950 feet), except passenger and container ships which may be 294.43 meters (966 feet) in

overall length. Vessels transiting the Canal for the first time at an overall length exceeding 274.32 meters (900 feet), whether newly-constructed or newly-modified are subject to the requirement of inspection and prior review and approval of vessel plans. Vessels not receiving advance approval and/or not complying with Canal requirements may be denied transit.

b) The maximum length for integrated tug-barge combination acceptable for regular transit of the Panamax locks is 274.32 meters (900 feet) overall including the tug. A tug-barge combination must transit together as one unit with the tug supplying the propelling power.

c) The maximum aggregate overall length for non-self-propelled vessels acceptable for transit of the Panamax locks is 259.1 meters (850 feet), including accompanying tugs. Accompanying tugs must lock through with the non-self-propelled vessel. One-time only transits that exceed these limitations may be permitted on a case-by-case basis with prior approval of the Transit Operations Division Manager, and subject to requirements listed in Paragraph 2.i (9).

(2) Maximum Beam

a) The maximum beam for commercial or non-commercial vessels and the integrated tug-barge combination acceptable for regular transit of the Panamax locks measured at the outer surface of the shell plate and all protruding structures below the lock walls is 32.31 meters (106 feet).

b) Wider commercial vessels including integrated tug-barge combination up to a beam of 32.61 meters (107 feet) may be permitted, with prior approval of the Transit Operations Division Manager, or his designee, to transit on a one-time delivery basis only if the deepest point of immersion does not exceed 11.3 meters (37 feet), TFW.

c) The maximum beam for non-self-propelled vessels (other than integrated tug-barge combinations) acceptable for transit is 30.5 meters (100 feet). One-time transit of wider vessels may be permitted with prior approval of the Transit Operations Division Manager, and subject to requirements listed in Paragraph 2.i (9).

d) Vessels that carry cargo within 2.5 centimeters (1 inch) or less of the extreme beam must have approved provisions, such as rubbing bands; to protect the cargo should the vessel rest alongside the wall while in the chamber. The maximum beam of 32.31 meters (106 feet) should not be exceeded by the cargo protection method. This is brought about by the large number of container vessels that are designed to load containers virtually to the extreme beam. If the ship lands on the wall in a heeled condition or where the locks wall fendering or miter gate fendering protrudes, damage may occur.

(3) Panamax Locks Maximum Draft

a) The maximum permissible draft for Canal transits using the Panamax Locks has been set at 12.04 meters (39 feet 6 inches) Tropical Fresh Water (TFW) at a Gatun Lake level of 24.01 meters (78.8 feet) or higher. [Gatun Lake density is 0.9954 gms/cc at 29.4° C (85° F).] This provides a safe navigational margin of at least 1.52 meters (5 feet) over

critical elevations in the Canal and a clearance over the south sill of Pedro Miguel Locks of 1 foot 8 inches (0.50 meters) at a Miraflores Lake Level of 16.61 meters (54 feet 6 inches).

b) Prior to the initial transit of a vessel whose transit draft will exceed 10.82 meters (35 feet 6 inches), owners, operators or agents must supply in full the information required in the Regulation on Navigation in Panama Canal Waters (ACP Navigation Regulations, Article 52), and request the maximum authorized transit draft for the vessel (deepest point of immersion TFW) from the Transit Operations Division Manager, not later than two weeks prior to the loading of the vessel. This request will be returned with the approved maximum authorized transit draft stamped thereon.

c) The initial transit is permitted at or under the approved maximum authorized transit draft. After the initial transit, unless the vessel's agent or owner is notified of any restrictions imposed by the Canal Authority, this maximum authorized transit draft will remain in effect.

d) **Figure 1** (p. 13) indicates the limiting drafts due to bilge radius. On an off center lockage with the vessel touching the lock wall, the turn of the bilge will clear the locks wall batters at the most critical point as shown in the table.

b. Vessels Transiting the Neopanamax Locks

(1) Maximum Length

a) The maximum length overall including bulbous bow for commercial or non-commercial vessels acceptable for regular transit of the *Neopanamax* locks is 367.28 meters (1205 feet). Vessels transiting the Canal for the first time, whether newly-constructed or newly-modified are subject to the requirement of inspection and prior review and approval of vessel plans. Vessels not receiving advance approval and/or not complying with Canal requirements may be denied transit.

b) The maximum length for integrated tug-barge combination acceptable for regular transit of the *Neopanamax* locks is 366.0 meters (1200.8 feet) overall including the tug. A tug-barge combination must transit together as one unit with the tug supplying the propelling power.

c) The maximum aggregate overall length for non-self-propelled vessels acceptable for transit of the *Neopanamax* locks is 400.0 meters (1312.3 feet), including accompanying tugs. Accompanying tugs must lock through with the non-self-propelled vessel. One-time only transits that exceed these limitations may be permitted on a case-by-case basis with prior approval of the Transit Operations Division Manager, and subject to requirements listed in Paragraph 2.j (9).

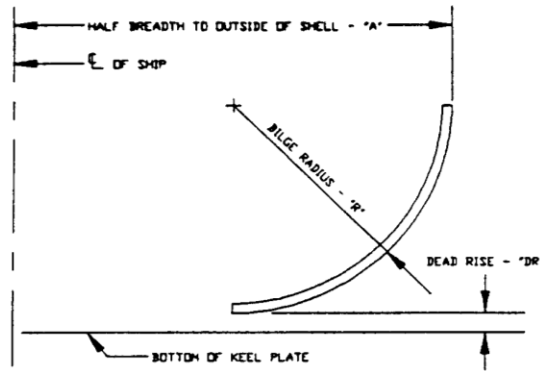

	Radius of turn of bilge (meters)				
	0.30	0.60	0.90	1.20	1.50
0.000	10.87	11.12	11.37	11.62	11.87
0.025	10.89	11.14	11.39	11.64	11.89
0.050	10.91	11.16	11.41	11.66	11.91
0.075	10.93	11.18	11.43	11.68	11.93
0.100	10.95	11.20	11.45	11.70	11.96
0.125	10.97	11.22	11.47	11.73	11.98
0.150	10.99	11.24	11.50	11.75	12.00
0.175	11.01	11.27	11.52	11.77	12.02
0.200	11.04	11.29	11.54	11.79	12.04
0.225	11.06	11.31	11.56	11.81	
0.250	11.08	11.33	11.58	11.83	
0.275	11.10	11.35	11.60	11.85	

	Radius of turn of bilge (feet)				
	1'	2'	3'	4'	5'
0'	35'8"	36'6"	37'4"	38'2"	39'0"
1"	35'9"	36'7"	37'5"	38'3"	39'1"
2"	35'10"	36'8"	37'6"	38'4"	39'2"
3"	35'10"	36'8"	37'6"	38'5"	39'3"
4"	35'11"	36'9"	37'7"	38'5"	39'3"
5"	36'0"	36'10"	37'8"	38'6"	39'4"
6"	36'1"	36'11"	37'9"	38'7"	39'5"
7"	36'2"	37'0"	37'10"	38'8"	39'6"
8"	36'3"	37'1"	37'11"	38'10"	
9"	36'3"	37'1"	38'0"	38'10"	
10"	36'4"	37'2"	38'0"	38'10"	
11"	36'5"	37'3"	38'1"	38'11"	

Example: To find draft of ship having a radius-of-turn-of-bilge of 1.325 m., read across top of table to column headed 1.20 m. thence down column opposite 0.125 m. Read 11.73 m.

Notes: a) Dead rise not included in above tabulations and must be added to above readings.
 b) Allows for 15-cm. thick rubber fenders on lock walls at batter locations

Example: To find draft of ship having a radius-of-turn-of-bilge of 4'4", read across top of table to column headed 4' thence down column opposite 4' - Read 38'5".

Notes: a) Dead rise not included in above tabulations and must be added to above readings.
 b) Allows for 6-inch thick rubber fenders on lock walls at batter locations.

FIGURE 1 - Limiting Drafts Due to Bilge Radius Contacting Chamber Batters

(2) Maximum Beam

a) The maximum beam for commercial or non-commercial vessels and the integrated tug-barge combination acceptable for regular transit of the *Neopanamax* locks measured at the outer surface of the shell plate and all protruding structures below the lock walls is 51.25 meters (168.14 feet).

b) The maximum beam for non-self-propelled vessels (other than integrated tug-barge combinations) acceptable for transit is 49.00 meters (160.76 feet). One-time transit of wider vessels may be permitted with prior approval of the Transit Operations Division Manager, and subject to requirements listed in Paragraph 2.i (9).

c) Vessels that carry cargo within 2.5 centimeters (1 inch) or less of the extreme beam must have approved provisions, such as rubbing bands to protect the cargo, should the vessel rest alongside the wall while in the chamber. The maximum beam of 49 meters (160.72 feet) must not be exceeded by the cargo protection method.

(3) *Neopanamax* Locks Maximum Draft

The maximum allowable draft for Canal transits using the *Neopanamax* locks has been set at 15.24 meters (50.00 feet) Tropical Fresh Water (TFW) at a Gatun Lake level of 25.91 meters (85.0 feet) or higher. [Gatun Lake density is 0.9954 gms/cc at 29.4° C (85° F).] This provides a safe navigational margin of at least 1.52 meters (5 feet) over critical elevations in the Canal.

c. *Other Draft Considerations*

(1) All vessels transiting the Canal should have sufficient ballast to permit safe handling during transit.

(2) A vessel whose ballast draft does not meet the minimum draft requirements established by this section may be accepted for transit on a regular basis, provided the vessel operator is granted permission after submitting the following information to the Transit Operations Division Manager:

(a) Principal dimensions of the vessel.

(b) Deepest attainable minimum draft (fore and aft).

(c) Limitations on visibility fore and aft from the navigation bridge.

(d) Necessary excerpts from the vessel's plans, drawings and maneuvering data that relate to the vessel's suitability for transit. The information submitted should include the proposed Panama Canal ballast condition detailed output, showing the status of all ballast and consumable tanks, plus the maneuvering data in accordance with IMO Resolution A.601 (15), Appendices 1, 2 and 3.

(3) **Table I**, on the next page, provides the minimum saltwater drafts for vessels anticipating transit. Drag (trim by the stern) must not adversely affect maneuverability. Any drag beyond 1.83 meters (6 feet) or one (1) percent of its LOA, whichever is greater, is considered adverse drag in the Panama Canal and adjacent waters.

(4) **Figure 1** (p. 15) provides the limiting drafts due to bilge radius. On an off-center lockage with the vessel touching the lock wall, the turn of the bilge will clear the locks wall batters at the most critical point as shown in the table.

(5) A vessel having received permission to transit at less than the minimum required draft will be inspected by the Authority upon its first visit under ballast conditions. If the vessel is acceptable for transit at less than the prescribed minimum draft, the operator will be notified that transit on a regular basis is authorized provided the vessel meets the special minimum draft specified in that notification and that the master signs a form releasing the Authority from liability.

LENGTH	MINIMUM DRAFT TSW
Up to 129.54 m (425 ft)	Trimmed so pilot can see the ranges over the forecastle from center of navigation bridge
Over 129.54 m (425 ft')	2.44 m (8 ft) forward, 4.27 m (14 ft) aft
Over 144.8 m (475 ft)	5.50 m (18 ft) forward, 6.01 m (20 ft) aft
Over 160.02 m (525 ft)	6.10 m (20 ft) forward, 6.71 m (22 ft) aft
Over 176.78 m (580 ft)	6.71 m (22 ft) forward, 7.32 m (24 ft) aft
Over 190.50 m (625 ft)	7.32 m (24ft) forward, 7.92 m (26 ft) aft
Over 304.80 m (1,000 ft)	7.92 m (26 ft) forward, 8.53 m (28 ft) aft
Over 335.28 m (1,100 ft)	8.53 m (28 ft) forward, 9.14 m (30 ft) aft

TABLE I - Minimum Salt Water Draft

(6) If the vessel is found not to be acceptable for transit on a regular basis, a single transit may be authorized, at the discretion of the Transit Operations Division Manager, subject to imposition of special conditions that may be required for reasons of safety or continuance of regular Canal operations.

(7) Vessels are expected to arrive at the Canal properly trimmed and with a draft which, when in fresh water, its deepest point of immersion will not exceed either the published TFW Draft, the Maximum Authorized Transit Draft established by the Canal for that particular vessel, or the maximum allowable draft as a mean established by the classification society, whichever is less.

(8) Vessels when transiting the Panamax locks with drafts exceeding these figures, when in Miraflores Lake, are subject to denial of transit. Northbound vessels found by actual reading to be overdraft would be required to turn around and proceed back to sea, and the transit would be considered completed. Southbound vessels will be held in the Gatun Anchorage. The transit will be reinitiated only after the Transit Operations Division Manager, considers that it is safe to proceed.

(9) Masters of vessels are reminded that personnel from transiting vessels are not permitted to climb or hang over the side of the vessel from ladders or boatswain's chairs while the vessel is in the lock chamber. Personnel are prohibited from disembarking onto the lock walls at any time for any purpose, except when expressly authorized by the Canal Port Captain office. Draft readings are obtained from locks personnel through the pilot.

(10) Potential Seasonal Draft Restrictions:

(a) In the event of lower than normal Gatun Lake levels, draft restrictions might become necessary.

(b) During the rainy season (from May to December), Gatun Lake and Madden Lake, the upstream reservoir for the Canal and the municipal water supply of Panama City, are

expected to be filled to capacity. During the dry season (from December to May), the Madden Lake reserve is drawn off to keep Gatun Lake at an optimum level. As the Gatun Lake level falls below 25.91 meters (85 feet) it becomes necessary to reduce the maximum allowable draft in the Neopanamax locks, and if the Lake level falls below 24.09 meters (79 feet), it becomes necessary to reduce the maximum allowable draft in the Panamax locks to preserve the safe navigation margin. The reductions are made in 15.24 cm (6 inch) decrements, with three week advance notice when possible, based on computer assisted lake level and precipitation forecasts made by the Authority's hydrologists and meteorologists. Ships already loaded to a prevailing draft limitation at the time of promulgation of a new draft restriction are waived for transit, subject to overriding safety considerations. Ships loading after promulgation of a new draft restriction are held to a tolerance of not more than 15.24 cm (6 inches) above that restriction and may be required to trim or off-load the ship to achieve a safe transit draft.

d. *Maximum Width*

Vessels with a maximum width exceeding its maximum beam may not transit the Canal without prior review and approval of vessel plans. Vessels not receiving advance approval and/or not complying with Canal requirements may be denied transit.

e. *Protrusions*

- (1) Anything which extends beyond a vessel's hull, except for the main anchors, shall be considered a protrusion and subject to all applicable laws and limitations.
- (2) The Authority is not responsible for damages to protrusions whether permanent or temporary.
- (3) Vessels with protrusions may be permitted to transit provided that such protrusions will not interfere with the safe transit of the vessel or present a hazard to Canal structures, as determined by the Transit Operations Division Manager. In either case, before transit is permitted, masters of vessels will be required to execute a form undertaking to release the Authority from liability in case of accident and to indemnify the Authority for damages sustained to or as a result of protrusions.
- (4) Vessels with permanent protrusions must, prior to proceeding to the Canal, furnish detailed information about the protrusion(s), including plans and request authorization for transit. Advance information will minimize the possibility that transit may be delayed or denied. For detailed information, contact the Transit Operations Division Manager.
- (5) Vessels with protrusions extending beyond the maximum length and beam limitations specified in paragraphs 2.a and 2.b of this Notice, may, on a case-by-case basis, be permitted to transit, provided that approval is obtained in advance from the Transit Operations Division Manager and that protrusions do not present a hazard or interfere with lock structures, equipment and/or operation, and the master executes a form releasing the Authority from liability (see Subsection 2.g).
- (6) In the Neopanamax Locks protrusions, cargo or extensions beyond the ship's side located 16.85 meters (55.268 feet) or less above the waterline are not acceptable; however,

extensions up to 4 meters (13.12 feet) beyond the hull and higher than 16.85 meters (55.268 feet) from the waterline will be reviewed on a case-by-case basis to verify the minimum clearance of 1000 mm (3.33 feet) from all equipment above the lock walls (such as valve stems, bits, etc.). Protrusions of up to 5 meters located higher than 22.87 meters (75.01 feet) or up to 6.5 meters (21.32 feet) and located higher than 25.44 meters (83.44 feet) over the waterline, will also be reviewed on a case-by-case basis to verify the minimum clearance is provided from all equipment (such as light posts, valve stems). See Annexes 2 and 3.

f. *Maximum Height*

The allowable height for any vessel transiting the Canal or entering the Port of Balboa at any state of the tide is 57.91 meters (190 feet) measured from the waterline to its highest point. With prior permission from the Transit Operations Division Executive Manager, height may be permitted to 62.5 meters (205 feet) on a case-by-case basis, with passage at low water (MLWS) at Balboa. Maximum Height Restrictions are due to the tide and the unpredictable upward movement of water from swells, surges, waves, etc., and maintenance equipment suspended beneath the bridge at Balboa.

g. *Release from Liability*

(1) Masters of vessels will, prior to transit, be required to execute a form undertaking to release the Authority from liability in case of accident and to indemnify the Authority for damages sustained in the following instances:

(a) When a vessel transits at less than the minimum drafts established in paragraph 2.c, has a list in excess of three degrees, or is so loaded or trimmed that maneuverability is adversely affected.

(b) When a vessel has protrusions.

(c) When visibility from the vessel's navigation bridge presents a hazard, as determined by the Transit Operations Division Executive Manager. (See Section 4 of this Notice.)

(d) When the vessel's chocks, bits or other equipment does not meet Canal requirements as determined by the Transit Operations Division Manager. (See Section 8 of this Notice.)

(e) When the length overall of the vessel, including bulbous bow, exceeds the length stated in Sections 2.a or 2.b.

(f) When the maximum width or extreme beam exceeds the width stated in Sections 2.a or 2.b by any amount.

(2) Pilots or boarding officers are requested to have the master of the vessel sign Form 4323, "Undertaking to Release and Indemnify", prior to docking vessels in Balboa, Cristobal and Rodman Piers when such vessels are exceeding the allowable drafts or when a vessel is to be berthed on a pier that has inadequate or absent fendering and/or lighting.

(3) A refusal to sign such release may result in a delay of transit.

h. Approval of Plans

(1) The plans for new construction or modification for each vessel or class of vessels should be submitted to the Transit Operations Division for review prior to modification or construction. A minimum of two and a maximum of four sets of copies of each drawing should be submitted. The ACP will retain for its records and files a single set of the drawings submitted and will return only up to three sets of copies of the principal drawings submitted. Failure to comply with this requirement may result in delay or denial of transit because of unsuitable or unsafe arrangements.

(2) The numerous constraints affecting the transit schedules of vessels and tows make it important that information provided in advance of the initial transit include the following documents for approval (a minimum of two copies of each drawing must be submitted):

- General Arrangement (indicating deployed boarding facilities, blue steering light and pilot shelters/platforms)
- Mooring Arrangement (indicating chock/bitt sizes and safe working load capacities)
- Wheelhouse Arrangement (showing required aids to navigation, such as indicators, wipers, horn controls, radar and others)
- Visibility Calculations (indicating compliance with ACP visibility requirements of Paragraph 4.e of this Notice)
- Section Views showing the vessel inside the lock chamber pressed against both center and side walls, indicating clearances of protrusions from lock structures and equipment (for vessels with protrusions – the locks chamber drawings are in Annexes 1, 2 and 3).

For reference (one copy of each drawing retained for our records):

- Midship Section (or Shell Expansion and bilge radius information, if the Midship Section is not available)
- Engine room plans
- International Tonnage Certificate
- International Load Line Certificate
- Detailed drawings of chocks and bitts showing sizes and maximum strain capacities, if not indicated in the mooring arrangement.

This advance information will minimize the possibility that transit might be denied due to noncompliance with Canal regulations. For detailed information, contact the Transit Operations Division Canal Port Captain South Section Manager (NTOS).

(3) Vessels that have had the appropriate plans approved will normally retain such approval unless it is determined by the Transit Operations Division Manager that modifications are necessary to ensure safe transit.

(4) The Transit Operations Division accepts electronic drawing submittals via e-mail to PlanApproval@pancanal.com or by courier/regular mail in flash memory USB.

(5) The drawings are to be saved preferably in PDF or TIFF file format, or in a file format compatible with AUTOCAD. All drawing and letter files may be compressed together into one zip/7z/rar file. Files exceeding 10MB must not be included within compressed files, instead they must be sent in their original format.

(6) Upon review, the submittals will be stamped electronically and returned via e-mail. In this manner, the recipient has control of printing any number of copies of the stamped drawings needed to meet distribution requirements.

i. Required Documentation for Initial Transit in Electronic Format

All vessels transiting the Panama Canal for the first time must provide the following documents in electronic format utilizing WORD, EXCEL, PDF, TIFF, JPEG or similar format:

- International Tonnage Certificate (ITC-69)
- PC/UMS Documentation of Total Volume or suitable substitute
- Volume calculations (If available)
- Suez Canal Certificate (If available)
- Load Line Certificate (If multiple Load Lines exist, provide the one with least freeboard)
- Pilot Card (Vessels speed and general information)
- Ship Particulars
- Certificate of Registry
- Ship Classification Certificate
- Minimum Crew Safe Manning Certificate
- International Sewage Pollution Prevention Certificate
- Passenger Ship Safety Certificate – Form P (for passenger vessels)
- Certificate of Fitness (for Chemical Tanker and Gas Carriers)
- Certificate of International Air Pollution Prevention Certificate (with the supplement)

The following drawings (plans) shall be provided in PDF or AUTOCAD format only, in one plan (not sections), in order to allow for precise calculations:

- General Arrangement Plan
- Capacity Plan with deadweight scale
- Midship Section Plan
- Lines Plan (if available)
- Shell Expansion Plan
- Docking Plan
- Visibility Plan
- Trim and stability booklet or hydrostatic information (summer loaded figures at zero trim for extreme draft, displacement, deadweight and tons of immersion)
- Lightship Test Report or Result Deadweight Measurement Report (for Dry bulkers)

- Container Loading or Stowage Plan when fully loaded (full container vessels only)
- Cargo Securing Manual (full container vessels only - All pages regarding container information above and below deck and all combinations available)
- Cargo Tank Calibration or Cargo Tank Gauging Table (only the cover page and the pages containing the Cargo Tank Capacity Summary) - only for Gas Carriers

The documents must be legible, of good quality, and shall include all pages. Please specify in the subject of the message, the vessel's current name, IMO number, and, if available, the vessel's SIN (Panama Canal Ship Identification Number).

The above-mentioned documentation must be submitted to Arqueadores@pancanal.com and ACP-Shipplans@pancanal.com at least 96 hours prior to arrival at Panama Canal waters.

Receiving this information in advance will expedite the vessel's scheduling process, the calculations required for the proper assessment of tolls, and facilitate the inspection process on arrival.

j. Denial of Transit

Any vessel may be denied passage through the Canal when the character or condition of the cargo, hull or machinery is such as to endanger Canal structures, or which might render the vessel liable to obstruct the waterway, or whose draft at any part of the vessel exceeds the maximum allowable draft as designated from time to time by the Canal Authority. Other specific circumstances under which a vessel may be denied transit are:

- (1) When the vessel's maximum point of immersion exceeds its maximum authorized draft as determined by its bilge keel radius.
- (2) When the vessel's maximum point of immersion exceeds the published TFW maximum draft then in effect.
- (3) When the vessel's mean draft exceeds the maximum allowable mean draft as provided by the most current Load Line Certificate.
- (4) When the length overall, including bulbous bow, exceeds the length stated in Sections 2.a or 2.b.
- (5) When the maximum width or extreme beam exceeds the width stated in Sections 2.a or 2.b by any amount unless the vessel was approved for regular transit prior to March 10, 1981.
- (6) When a vessel has protrusions, which will interfere with the safe transit of the vessel or present a hazard to Canal structures as determined by the Transit Operations Division Manager.
- (7) When the vessel has a list of ten degrees or more.
- (8) When visibility from the navigation bridge of a vessel does not meet minimum requirements as stated in Section 4.d and/or when in the judgment of the Transit Operations Division Manager transit would present an extreme hazard.

(9) Vessels whose list, trim or handling characteristics are such as to endanger themselves, ACP appurtenances and/or a third party, may have such further limitations placed on them as the Canal Authority deems necessary to insure reasonable safety.

k. *Vessel Should Be Able to Relay at the Locks*

Due to the increase in numbers and size of transiting vessels, relay lockage procedures have become the norm. This lockage procedure involves mooring to the lock wall inside the lock chamber; casting off all locks locomotives and receiving a different set of locks locomotives to continue the lockage. During this process, the affected vessel is subject to the vagaries of the wind and any associated lockage currents, and may contact the lock wall. Such contact may involve heeling of the vessel, which would bring the hull shell plating and any protrusions thereto, closer to the locomotives at the very time the locomotive must pass down the length of the vessel. Measures must be taken to ensure the safety of the vessel, locks equipment and their operators. To that end, all new vessels must maintain a minimum clearance of 1 meter (3.3 feet) between any locks equipment and any protrusions extending beyond the vertical plane of the hull shell plating at the waterline. Additionally, any vessel with windows, port lights, doors, side ports or other critical appurtenances below a level of 12.9 meters (42.2 feet) above the waterline at transit draft must take measures to ensure its protection in case the vessel contacts the lock wall.

3. Requirement for Pilot Platforms and Shelters on Certain Vessels

a. As required by the *ACP Navigation Regulations, Article 64*, suitable platforms and shelters must be provided by certain vessels for assisting pilots. Control pilots will position assisting pilots where they can best contribute to vessel control, which may be at any of the existing pilot platform locations:

(1) Vessels with the bridge in the extreme after part of the vessel (assisting pilot platforms will normally be forward).

(2) Vessels with the bridge in the extreme forepart of the vessel (assisting pilot platforms will normally be aft).

b. Platforms must afford suitable shelter to protect assisting pilots from rain and sun. **Figure 2** (p. 26) is a sketch of a simplified pilot platform acceptable to the Authority.

c. Each platform is to be erected directly over the furthest point forward of the extreme beam at the waterline and not more than six inches inboard from the outside of the vertical plane of the shell plating. For vessels where the bridge is located forward, these pilot platform shelters will be required to be erected directly over that position which is the furthest point aft of the extreme beam at the waterline and not more than six inches inboard from the outside surface of the vertical plane of the shell plating.

d. In addition, all vessels whose extreme beam is 24.38 meters (80 feet) or more are required to provide bridge wing shelter platforms for the protection of control pilots at Conning Positions No. 4 and 5. **Figure 3** (p. 27) is a sketch of a bridge wing shelter platform

acceptable to the Authority. Alternate arrangements, including portable shelters, which provide equivalent or better protection and visibility, may be acceptable.

e. The awning indicated in the sketches in **Figures 2** and **3** is to be made of suitable material to provide shelter from the sun and rain. The deck of pilot platforms shall be made of wood or other material with non-skid surface, sufficient to dry footing at all times. Overhead awning should be rigged to avoid spilling water inside the framework of the shelter during rain.

f. Further inquiries on this subject should be directed to the Transit Operations Division Manager.

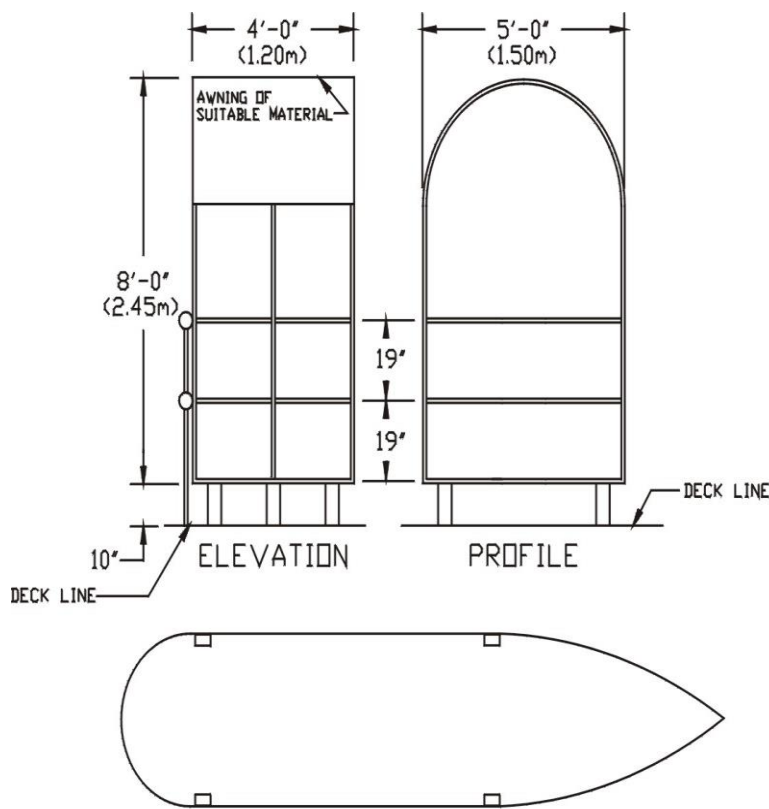

FIGURE 2 – Pilot Platforms

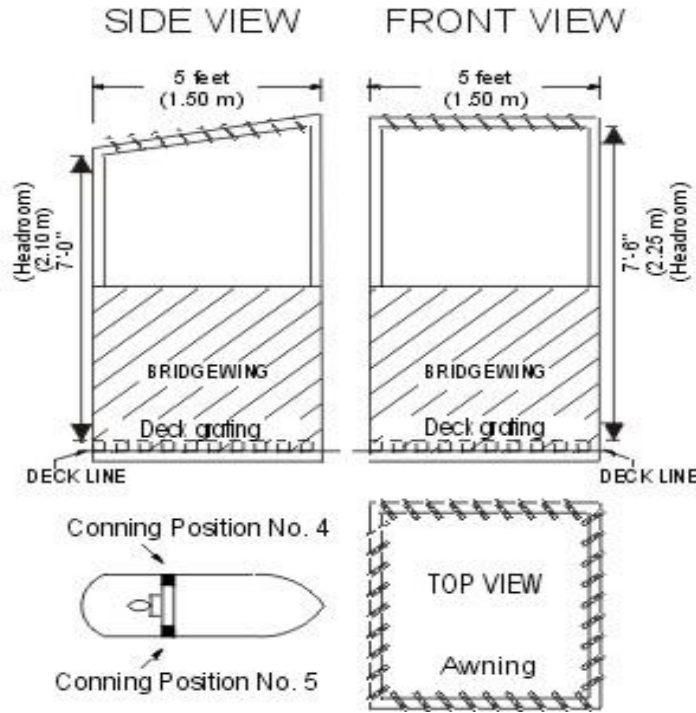

FIGURE 3 - Pilot Shelters

4. Navigation Bridge Features Required of Transiting Vessels

a. *Authority* - The following vessel bridge design rules are issued under authority of the *ACP Navigation Regulations, Articles 29, 50, and 61 to 64*. Vessels not meeting the requirements of these rules after January 1, 1980, may, at the discretion of the Canal Authority, be allowed to transit after execution of an undertaking and release form. This undertaking and release form is to be made on behalf of the owners, operators, master and all other persons having an interest in the vessel and shall provide that in case of damage of any sort proximately resulting from non-compliance with these rules, the Canal will be released from any liability and will be indemnified for any damage or expense incurred.

b. *Wheelhouse* - Wheelhouse windows shall be:

- (1) Of sufficient size and number to provide a clear view.
- (2) Of clear safety glass. Tinted windows must be removable.
- (3) Arranged so as to include a center window.
- (4) Equipped with an efficient, mechanically, operated rain wiper blade on the window at the normal bridge Conning Position 1. In the case of vessels with a center crane or other type of obstruction, blade type wipers shall be located on the windows at normal bridge Conning Positions 2 and 3. In case of enclosed bridge wings, blade type wipers shall be located also on the forward and aft windows at Conning Positions 4 and 5.

c. *Bridge Wings* - Bridge wings shall provide a clear, unobstructed passageway of at least 1.0 meters (3.28 feet) in width along their forward portions from the wheelhouse doors to the extreme ends of the bridge wings. If it is impossible to extend these bridge wings the full breadth of the vessel, they shall extend as far as possible and swing-out or portable platforms shall be provided as follows:

- (1) Extending to the maximum beam of the vessel.
- (2) Of adequate size, strength and rigidity to hold two persons.
- (3) Equipped with horizontal safety handrails and a toe board around the deck, 4-inches high minimum.
- (4) Platforms shall be safe and secure and maintained in good condition.

d. *Normal Conning Positions* (see **Figure 4** on the following page).

- (1) Conning Position 1 is located directly behind and close to the forward center wheelhouse window.
- (2) Conning Position 2 is located to port of Conning Position 1 directly behind and close to the nearest window thereto that provides a clear unobstructed view ahead.
- (3) Conning Position 3 is located to starboard of Conning Position 1, directly behind and close to the nearest window thereto that provides a clear unobstructed view ahead.
- (4) Conning Position 4 is located at the extreme end of the port bridge wing and must provide a clear and unobstructed view fore and aft of the vessel's port side.
- (5) Conning Position 5 is located at the extreme end of the starboard bridge wing and must provide a clear and unobstructed view fore and aft of the vessel's starboard side.
- (6) No equipment or instrumentation shall block the close approach to the forward windows at Conning Positions 1, 2 and 3 and from the forward to after portions of the bridge wing ends at Conning Positions 4 and 5. A minimum of 1.0 meters (3.28 feet) clearance from consoles or obstructions should be provided in these areas. Special requests for relaxation of this requirement may be considered on a case-by-case basis. Inset navigation lights fitted on the bridge wing ends are unacceptable, as they block the pilot's close approach to these areas. Bridge wing controls shall be so positioned that neither the controls nor the operator interfere with the pilot's functions.

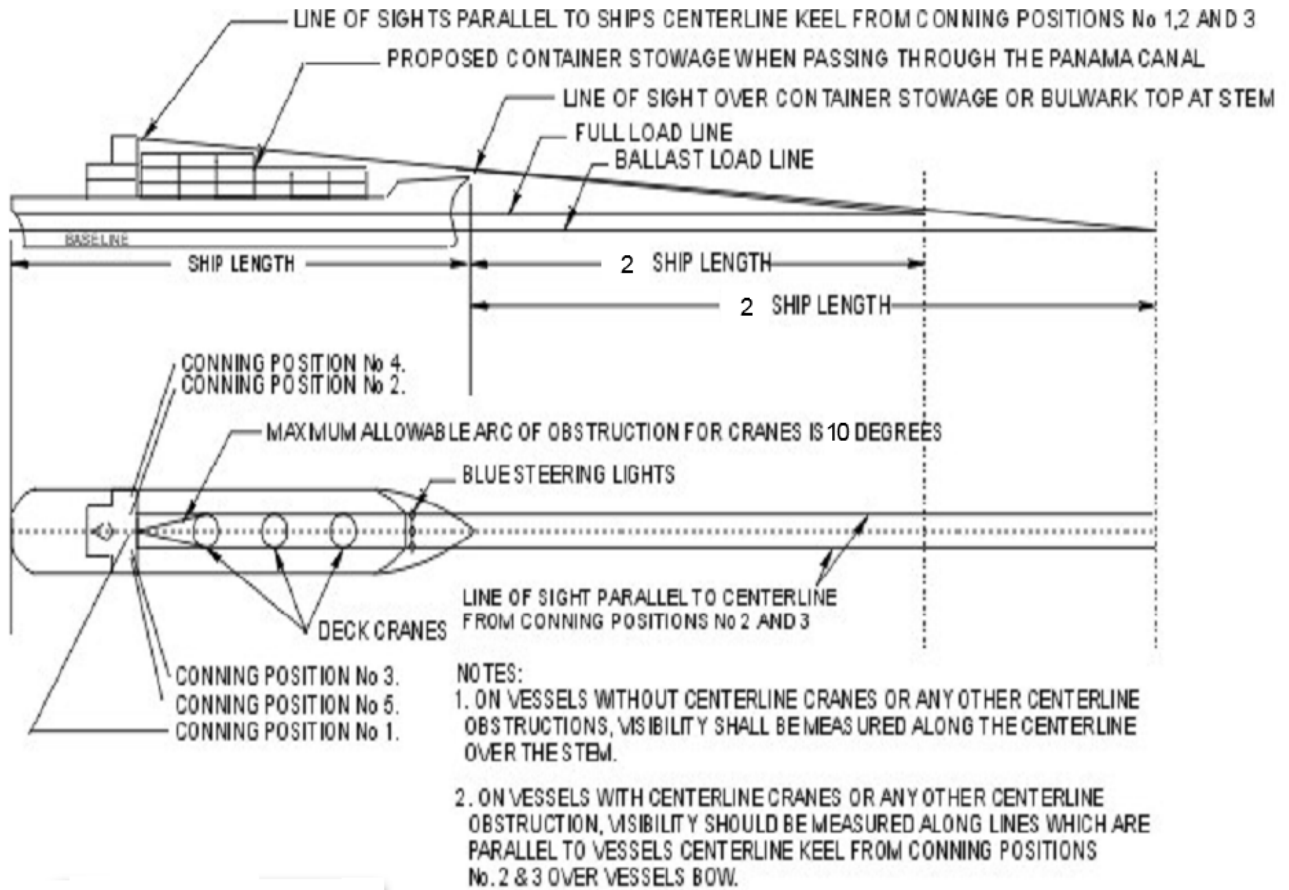

FIGURE 4 - Normal Conning Positions

Note: *Vessels with enclosed bridge wings must provide a means for the pilot to have a clear and unobstructed view of the vessel sides as required by paragraphs 4.d (4) and (5) above. This may require an opening type window to be fitted on the outboard bulkhead of each bridge wing to allow the pilot to view the waterline all along the side of the vessel; or, when catwalks are fitted that extend to the maximum beam of the vessel, a 2.134 meters (7 feet) high by 0.915 meters (3 feet) wide door should be provided on the outboard bulkhead of each bridge wing in order to allow the pilot to step out onto the catwalk and look over the railing to view the waterline all along the side of the vessel.*

e. Panama Canal Minimum Visibility Requirements

(1) Vessels transiting the Panama Canal must comply with the following navigation bridge minimum visibility requirements:

(a) For all conditions of draft and trim, the view of the water surface from conning positions 1, 2 and 3 in the navigation bridge shall not be obscured by more than two (2) ship lengths, or 500 meters forward of the bow, whichever is less, straight ahead to 10 degrees to either side from each of the conning positions.

(a) If the visibility from normal conning positions is obscured by cargo gear or other permanent obstructions forward of the beam, the total arc of obstructed visibility shall not exceed 10 degrees.

(b) The side hull plating at the vessel's waterline, fore and aft, shall be visible from bridge wing conning positions.

(c) Vessels shall be required to execute an Undertaking and Release if visibility from the bridge is considered by the Canal Authority to present a hazard.

(d) Vessels that do not comply with these visibility requirements due to cargo, cargo gear, structures, or any other reason, shall correct the deficiency in order to transit. If the deficiency cannot be corrected, the vessel shall inform the ACP at least 48 hours prior to arrival in order to take the necessary actions and minimize the possibility of transit delays. This notification shall be made through the ACP's Maritime Service Portal or any other means acceptable by the ACP. If information regarding deficiencies is not received prior to arrival, the vessel will be considered in compliance; however, if deficiencies are detected upon arrival, the vessel may experience transiting or docking delays, and may also be subject to additional charges.

(e) Vessels failing to meet ACP visibility requirements, for which notification was not received as required in Paragraph (e) above, may be subject to delays and charges above the regular service charge.

(f) The ACP will determine the conditions under which non-compliant vessels may be allowed to transit or dock. Vessels that require additional resources due to their visibility condition, will be assessed the corresponding charges.

(2) Notwithstanding the visibility requirements established herein, full container vessels of 700 feet or over in length overall and 100 feet or over in beam transiting in laden condition with a blind distance that exceeds 1 ship length will be assessed fees based on vessel dimensions, in accordance with official ACP tariff items #1065.0001 or #1065.0002.

Upon arrival at Canal waters, the "Blind Distance Declaration," Form 1746 (OPTC-A), available at <http://www.pancanal.com/common/maritime/forms/1746.doc> shall be completed by the master and presented to the ACP Boarding Officer. Please be advised that the "Pre-Arrival Vessel Information," Form 1743 (OPT), and the detailed Visibility Declaration required in the Maritime Service Portal are no longer required.

(3) All vessels that arrive for transit not in compliance with the Panama Canal visibility requirements as outlined above are subject to the conditions and service charges. Any denial of transit or transit delays experienced due to non-compliance of the above or any other non-compliance will not be considered as an acceptable justification for claims from vessels for delays in navigation, in accordance with Article 6 of the "Maritime Regulations for the Operations of the Panama Canal."

Note: *Vessel owners are encouraged to raise the height of the navigation bridge of their existing vessels and to have new vessels designed and built with higher navigation bridges so as to provide navigators the best possible visibility.*

(4) Regulation on Pre-Arrival Information Required for Transit

(a) The ACP reminds customers that Article 30 of the Regulation on Navigation in Panama Canal waters establish that all vessels arriving for transit or port calls at the terminal ports of Balboa and Cristobal shall provide the required information not less than 96 hours in advance of arrival. Timely submittal of this information is essential for appropriate assignment of resources and applicable restrictions, if necessary.

(b) Additionally, vessels over 45.72 meters (150 feet) LOA are required to submit Form 1743, Pre- arrival Vessel Information, no later than 48 hours prior to arrival. The visibility from conning positions 1, 2, and 3 reported in this document shall be expressed in ship lengths calculated for tropical salt water.

(c) Revisions to arrival information previously submitted are permitted no later than 36 hours without affecting the vessel’s transit schedule, but such notification must be sent to Arqueadores@pancanal.com. Failure to do so may result in the assignment of resources and the application of charges based on previously submitted information.

(d) Non-compliance with these requirements, or providing incorrect or incomplete information, may delay the transit or docking of the vessel.

(e) The following formulas shall be used to calculate the blind distance and visibility length:

$$BD = \left(\frac{Dh + Lc \left(\frac{Dh1 - Dh}{LBP + Lc - La} \right) - Draft - \left(\frac{Trim}{2} \right)}{\left(\frac{Trim}{LBP} \right) + \left(\frac{Dh1 - Dh}{LBP + Lc - La} \right)} \right) - Lc$$

VL = BD / LOA

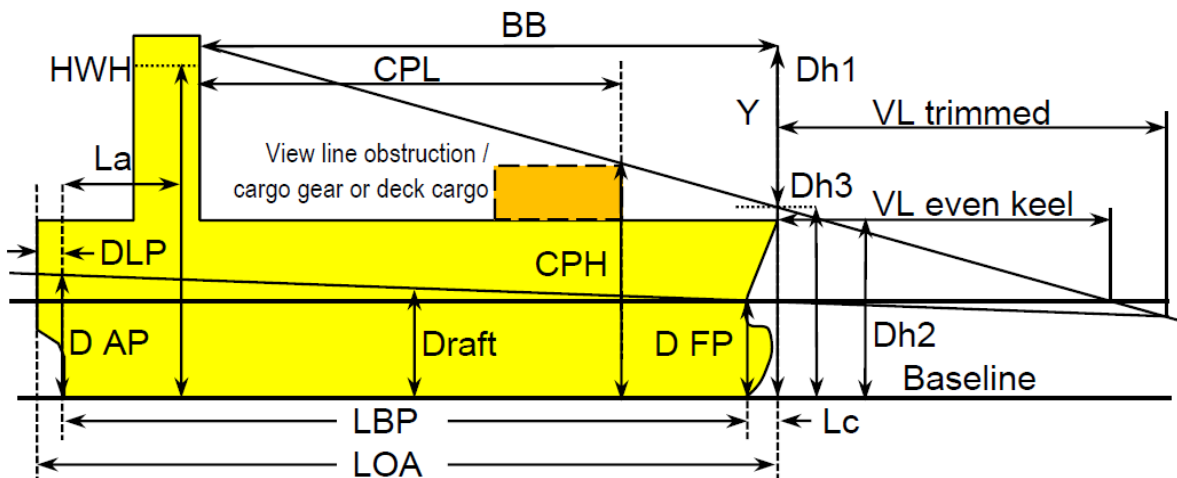

Where:

VL = Visibility in ship Length

BD = Blind Distance

LOA	= Length Over All
LBP	= Length Between Perpendiculars
BB	= Longitudinal distance from wheelhouse front Bulkhead to Bow
La	= Longitudinal distance from the After Perpendicular (AP) to pilot position = LOA – BB – DLP – 0.75
Lc	= Longitudinal distance from the Forward Perpendicular (FP) to the Bow = LOA – LBP – DLP
Dh1	= Height from baseline to wheelhouse deck plus 1.8m = HWH + 1.8
HWH	= Height from baseline to Wheelhouse deck
Dh	= Highest value between the heights resulting from Dh2 and Dh3
Dh2	= Height from Baseline to top of Bow
Dh3	= Height at bow from baseline to intercept of obstructed view line = Dh1–Y
Y	= Height from view line obstruction/cargo gear or deck cargo to pilot's height of eye projected to the bow of the vessel = (Dh1–CPH)(BB+0.75)/(CPL+0.75)
CPH	= Critical Point Height from baseline to top of deck cargo obstructing the view line
CPL	= Critical Point Length from the wheelhouse front bulkhead to the view line obstruction/cargo gear or deck cargo
DLP	= Distance Longitudinal from transom to the after Perpendicular (AP)
Draft	= Mean of drafts at the perpendiculars = (D AP + D FP) ÷ 2
Trim	= Trim of the vessel (negative by the stern, positive by the head) = D FP – D AP
D AP	= Draft at the After Perpendicular (AP)
D FP	= Draft at the Forward Perpendicular (FP)

Note: The longitudinal pilot position and pilot's height of eye used in the above calculations conform to Regulation 22.1.8 of SOLAS 2009 Chapter V, which states *"The upper edge of the navigation bridge front windows shall allow a forward of the horizon, for a person with a height of eye of 1,800mm above the bridge deck at the conning position"*. The longitudinal distance of the pilot position for use in the above is clarified as 0.75m aft from the wheelhouse front bulkhead. Metric units shall be used in the above formulas.

(f) To facilitate the pre-arrival process and provide for expeditious scheduling of vessels, a copy of the General Arrangement Plan must be sent to Arqueadores@pancanal.com or ACP-Shiplans@pancanal.com, in PDF or AutoCAD format, at least 96 hours prior to the vessel's ETA.

f. *Indicators* - All vessels over 45.72 meters (150 feet) in length shall be provided with:

(1) *Rudder angle indicators as follows:*

(a) On vessels less than 24.38 meters (80 feet) in beam, at least one of such design and placement that it can be easily read by day or night from all normal conning positions and from the steering station.

(b) On vessels 24.38 meters (80 feet) or more in beam, at least one inside the wheelhouse and one on each bridge wing, of such design and placement so that at least one can be easily read by day or night from each conning position and from the steering station.

(c) They shall show in degrees clearly and accurately the position and direction of the rudder or rudders. It shall be noted that indicators located aft of the conning positions will not be considered as meeting this requirement. Overhead rudder angle indicators located behind the pilot's conning positions are not acceptable. Rudder angle indicators mounted on overhead panels should be located as close to the forward bulkhead as possible for most efficient viewing by the pilot.

(2) Propeller revolution tachometer indicators as follows:

(a) On vessels less than 24.38 meters (80 feet) in beam, at least one for each propeller, of such design as to be easily read by day or night from all normal conning positions.

(b) On vessels 24.38 meters (80 feet) or more in beam, at least one for each propeller located inside the wheelhouse and one for each propeller located on each bridge wing, of such design and placement so that at least one can be easily read by day or night from each conning position.

(c) Indicators shall show revolutions per minute clearly and shall accurately indicate the direction of the propeller or propellers. It shall be noted that indicators located aft of the conning positions will not be considered as meeting this requirement.

(d) All vessels with variable pitch control indicators will have them so located as required in (a) and (b) of this subsection.

(3) Controllable pitch propeller indicators as follows:

(a) On vessels less than 24.38 meters (80 feet) in beam, at least one for each propeller, of such design as to be easily read by day or night from all normal conning positions.

(b) On vessels 24.38 meters (80 feet) or more in beam, at least one for each propeller located inside the wheelhouse and one for each propeller located on each bridge wing, of such design and placement so that at least one can be easily read by day or night from each conning position.

(4) Indicators must be operational: Vessels with missing or broken indicators may expect transit delays.

g. Very High Frequency (VHF) Radio - Every power-driven vessel of 300 gross tons or over, every power-driven vessel of 100 gross tons or over carrying one or more passengers for hire, and every commercial towing vessel of 7.92 meters (26 feet) in length or over shall be equipped with at least one VHF transceiver as follows:

(1) Must be operable from the navigational bridge and located near Conning Position 1.

(2) Must be equipped with International Channels 12 (156.00 MHz), 13 (156.650 MHz) and 16 (156.800 MHz).

h. Whistle Controls - Vessels shall be provided with whistle controls as follows:

- (1) On all vessels, one within easy reach on the navigational bridge from Conning Positions 1, 2 and 3, as described in Paragraph 4.d, preferably on the forward bulkhead.
- (2) If the beam of the vessel is over 15 meters (49.2 feet), additional controls shall be provided within 1.52 meters (5 feet) of the extreme end of bridge wings at Conning Positions 4 and 5.
- (3) Controls shall make it possible to regulate precisely any required whistle signal.

i. Steering Light

- (1) All vessels over 100 meters (328 feet) in length shall have installed, at or near the stem, a steering range equipped with a fixed blue light which shall be clearly visible from the bridge along the centerline. The height of the light is to be as close as possible to the height of eye level on the bridge. If said range and light so placed would be partially or completely obscured from Conning Position 1, then two such ranges and lights must be installed ahead of Conning Positions 2 and 3. The wheelhouse position directly aft of the steering lights shall be marked with a small labeled plaque on the window sill which can be located in the dark by feel.
- (2) Naval or military vessels exempted from the requirements of 72 COLREGS (see *ACP Navigation Regulations, Article 108*) shall also be exempted from the requirements of this article.
- (3) The light required shall be capable of being illuminated and extinguished by a suitable rheostat or control switch located either on the navigation bridge or forecastle deck, or both.
- (4) The control or rheostat switch for the steering light shall also have dimming capabilities in order to adjust the intensity of the light to different backgrounds or atmospheric conditions.
- (5) The use of this steering light shall be at the discretion of the Canal pilot who has control of the navigation and movement of the vessel.

j. Bow/Stern Thrusters - Vessels equipped with bow/stern thrusters should provide controls located at the extreme ends of the bridge wings, as well as inside the wheelhouse.

k. Compass

- (1) Ships of 150 gross tonnage (ITC69) and over shall be fitted with a standard magnetic compass and with a steering compass unless the information provided by the standard compass is made available and is clearly readable by the helmsman at Conning Position 1. Means must be available for taking bearings, as nearly as practicable over an arc of the horizon of 360°. Residual deviation of the magnetic compass must be verified to be less than 7 degrees by swinging the vessel on various headings. Such verification by a recognized calibration authority must have been accomplished, and an accurate deviation table issued, within the previous 12-month period. If necessary, the compass must be adjusted to reduce the observed deviation to less than 7 degrees. Calibration cards issued and signed by the master will be accepted as long as the deviation is less than 6 degrees.

Ships of less than 150 gross tonnage shall be fitted with a steering compass and have means for taking bearings.

(2) Ships of 500 gross tons (ITC69) and over shall be fitted with a gyro compass. The master gyro compass or a gyro repeater shall be clearly readable by the helmsman from the main conning position. On ships of 1,600 gross tonnage (ITC69) and over, a gyro repeater or gyro repeaters shall be provided and shall be suitably placed for taking bearings as nearly as practicable over an arc of the horizon of 360°. A gyro repeater shall be provided which shall be readily visible and useable by the pilot from Conning Position 1. Maximum residual steady state gyro error shall not exceed 2°. The maximum divergence in reading between the master compass and repeaters under all operational conditions should not exceed plus or minus 0.5°.

(3) Vessels not in full compliance with these requirements should expect transit delays during periods of fog or inclement weather, a common occurrence in the Republic of Panama coincidental with the rainy season (May to December).

Note: *The ACP now requires that whenever a magnetic compass is calibrated or repaired in Panama Canal waters, the vessel's master must sign the ACP boarding officer's inspection checklist, corroborating that the magnetic compass was serviced using the appropriate procedures and that the equipment is in proper working order for the transit. A compass deviation card issued in Panama Canal waters without the corroborating signature of the master will not be accepted as valid and will be considered as a vessel deficiency.*

l. Course Recorders - Vessels fitted with devices for recording engine orders and responses, movement of the rudders and changes in the ship's heading shall have them operating while navigating in Canal waters.

m. Bridge Wing Spotlights - A spotlight or searchlight capable of illuminating the side of the vessel at the waterline is required to be fitted at the extreme end of each bridge wing on all vessels whose maximum beam is 30 meters (98.4 feet) and over. For all vessels, such lights should be of the hinged type and located on the after portion of the bridge wing to allow them to be swung out of the way behind the bridge wing when not in use, or mounted below the bulwark if fitted forward. The normal work position of the pilot on the bridge wing is at the forward outboard corner where he can look forward and down, as well as over the side and aft. Lights, bearing repeaters and other equipment must not interfere with the pilot's ability to do that.

n. Radar

(1) Ships of 500 gross tonnage (ITC69) and over shall be fitted with a properly functioning radar installation.

(2) Ships of 10,000 gross tonnage (ITC69) and over shall be fitted with two properly functioning radar installations, each capable of being operated simultaneously with and independently of the other.

o. Main Propulsion Systems

(1) Notwithstanding that the propulsion is controlled from the bridge or the engine room, the maximum allowable response time of the propulsion system from stop to ahead or from stop to astern shall not exceed 10 seconds.

(2) The total capacity of air receivers is to be sufficient to provide, without their being replenished, not less than 12 consecutive starts alternating between Ahead and Astern of each main engine of the reversible type, and not less than six starts of each main non-reversible type engine connected to a controllable pitch propeller or other device enabling the start without opposite torque.

(3) Vessels having main engines arranged for air starting, shall have at least two air compressors, capable of charging the main air containers in no more than 60 minutes to the requirements of Paragraphs 4.o (2)

(4) Where the main engine is arranged for electric starting, two separate batteries are to be fitted. The arrangement is to be such that the batteries cannot be connected in parallel. Each battery is to be capable of starting the main engine when in cold and ready to start conditions.

(5) Where remote control of propulsion machinery is provided, the remote control of propulsion machinery shall be in good operating conditions.

(6) In the event of failure in any part of the automatic or remote control systems, it shall be possible for the propulsion machinery to be controlled from a local position.

(7) At least two independent means shall be provided for communicating orders from navigation bridge to the position in the machinery space or in the control room from which the engines are normally controlled: one of these shall be an engine room telegraph which provides visual indication of the orders and responses both in the machinery space and on the navigation bridge.

(8) Where remote control of propulsion machinery from the navigation bridge is provided, an alarm on the navigation bridge and in the machinery space must indicate when a low starting air pressure condition exist. This alarm shall be set at a level to permit further main engine starting operations.

(9) Internal combustion engines intended for the propulsion of the ship shall have their external high-pressure fuel delivery lines between the high-pressure fuel pumps and fuel injectors, protected with a jacketed piping system capable of containing fuel from a high-pressure line failure. A jacketed pipe incorporates an outer pipe into which the high-pressure fuel pipe is placed, forming a permanent assembly.

(10) Computer or electronic controlled main engines shall have the cancel limits or program functions operational and ready to be use as necessary.

p. Use of Automatic Identification System (AIS)

The ACP has implemented mandatory carriage of Automatic Identification Systems (AIS) in Panama Canal waters. In order to be accepted for transit through the Panama Canal, all vessels over 300 gross tons or over 20 meters LOA must be equipped with an

AIS transponder that meets the standards set by the International Maritime Organization (IMO). With regard to combined and multiple units (tug-and-tows), only the tug will be required to be equipped with an AIS transponder.

Shipboard AIS transponders shall comply with the following requirements:

(1) The AIS system installed onboard vessels shall be Class A AIS ship borne equipment according to IMO MSC 74 (69) Annex 3, "*Recommendation on Performance Standards for a Universal Ship borne Automatic Identification Systems (AIS)*", as amended.

(2) The AIS equipment shall be type-approved according to standard IEC 61993-2. The Panama Canal Authority may require presentation of the type approval document. Some transponders have old firmware versions, which will not function properly. The make and model of these units, however, may be the same as those of the newer type-approved version. Normally, this condition can be corrected by installation of a newer firmware version in the AIS equipment and obtaining the type approval papers.

(3) The AIS equipment shall be installed according to IMO "*Guidelines for Installation of Ship borne Automatic Identification System (AIS)*", including the installation of a Pilot Plug. The Pilot Plug shall be close to conning position No. 1 on the navigation bridge. This plug shall be labeled "AIS PILOT PLUG", and shall have nearby a USA standard (NEMA 5-15R) 120V, AC, 3-prong power receptacle, to provide power to the pilot's laptop computer. This receptacle shall be connected to emergency power.

The IMO "*Guidelines for Installation of Shipborne Automatic Identification System (AIS)*" are available on the web page of the IMO at the following address: <http://www.imo.org/en/OurWork/Safety/Navigation/Documents/227.pdf>

The ACP has been monitoring the signals sent by ships already fitted with AIS. Some of these signals reveal deficiencies, which would make them unusable for transiting the Panama Canal. The most common deficiencies found so far are:

(1) Ship's static data is loaded incorrectly or not present at all. For example, we have seen ships reporting dimensions that are, obviously, incorrect.

(2) Some ships are not transmitting heading information. The connection of the ship's gyro to the AIS is required.

(3) On some ships, although the AIS system seems to be connected to the gyro compass, the heading information we are receiving shows the vessel with a different heading than the actual heading of the vessel.

(4) Some ship borne AIS stations do not respond to shore station commands, especially AIS Message 16, which is the "Assigned Mode" command, and AIS Message 17, which is "DGNSS broadcast binary message". The cause is probably outdated firmware. All AIS ship borne units shall use Message 17 data when received to correct the internal GPS position and use it to broadcast its position.

(5) Incorrect location of the Pilot Plug on the bridge and/or the installation not following IMO's "*Guidelines for Installation of Shipborne Automatic Identification System (AIS)*".

(6) The vessel may have incorrect offsets entered for its AIS-GPS antenna which can result in position errors.

Experience has shown that harnessing today's leading-edge maritime technology reaps a rich harvest of benefits. The Panama Canal Authority has participated extensively in AIS discussions at the IMO, as well as in the technical meetings at IEC and IALA. Shore side AIS stations have been in place for testing since May 2002. The benefits of this satellite-based vessel navigation aid for commercial vessels will apply to all Panama Canal users. Reduced delays, improved safety, increased security and better logistical management of ship, canal, and dock assets are just some of the benefits of this system, which will generate improvements in efficiency in an increasingly cost-conscious world.

The amendments to Regulation 19, Chapter V, of the International Convention for the Safety of Life at Sea (SOLAS 74) replaced the existing subparagraphs .4, .5 and .6 of paragraphs 2.4.2 with a new subparagraph .4 that requires all vessels, other than passenger ships and tankers, of 300 gross tonnage and upwards, but less than 50,000 gross tonnage, to have AIS installed not later than their first safety equipment survey conducted between the dates of July 1 and December 31, 2004. Subparagraphs .1, .2, and .3 of paragraph 2.4.2 of this same regulation remain in effect. Passenger ships and Tankers are covered by subparagraphs .1 and .2, respectively. However, the Panama Canal recognizes that not all vessels will have their permanent AIS systems installed until December 31, 2004; therefore, vessels will have the choice of a rental AIS ready vessel tracking portable unit from the ACP.

In addition, the Panama Canal will make an exception with older ships that only have 100VAC to 110VAC electrical service available on the bridge, instead of the required 120VAC, as well as with those vessels that have a 2-prong USA standard electrical outlet, instead of the required 3-prong outlet. This lower voltage and type of outlet (NEMA 1-15R) will be acceptable; however, the Canal will not accept vessels with 220-240 VAC electrical service.

All *Neopanamax* vessels intending to transit the Panama Canal must install a USA standard (NEMA5-5-15R) 120V, AC, 3-prong power receptacle close to the designated location of the RTK antenna, which is part of the Pilot Portable Unit (PPU) utilized by Panama Canal pilots.

We are hereby establishing the date for the installation of the power receptacle shall be no later than February 28, 2017.

Vessels that cannot comply with the installation of the required power receptacle outside the wheelhouse due to the nature of their cargo are exempt from this compliance; however, these vessels must provide an extension cord and an alternate access to route the extension cord from a power receptacle inside the wheelhouse to the PPU antenna on the bridge wing. This will prevent the antenna power cable from being slashed and/or ruptured by the bridge wing doors.

Finally, vessels equipped with an AIS system that is not working properly, or it is not programmed properly, may be provided with a rental portable AIS-ready vessel tracking unit for the transit, which will be charged to the vessel.

q. *Steering Gear*

(1) All crew members working on the bridge must be familiar with the steering gear switch-over procedures and with the use of emergency steering device.

(2) Steering gear controls at the wheelhouse shall provide for the expedite change-over from steering Follow-Up mode to Non Follow-Up mode, within the helmsperson position at the bridge.

(3) In the event of a power failure to any one of the steering gear power units, an audible and visual alarm shall be given on the navigation bridge.

(4) The main steering gear and rudder stock shall be capable of putting the rudder over from 35° on one side to 35° on the other side with the ship at its deepest seagoing draught and running ahead at maximum ahead service speed and, under the same conditions, from 35° on either side to 30° on the other side in not more than 28 seconds.

(5) The auxiliary steering gear should be capable of putting the rudder from 15° on one side to 15° on the other side in not more than 60 seconds.

(6) Where the auxiliary steering is not provided and the main steering gear comprises of two or more identical power units, for a:

(a) Passenger ship, the main steering gear shall be capable of operating the rudder to the requirements of Paragraph (4), above, while any one of the power units is out of operation.

(b) Cargo ship, the main steering gear shall be capable of operating the rudder to the requirements of Paragraph (4), while all of the power units are in operation.

5. Requirements for Non-Self-Propelled Vessels

a. Non-self-propelled vessels, other than integrated tug-barge combinations, will be accepted only on an individual basis; advance permission for initial transit as a non-self-propelled vessel is required. Displacement of these vessels is limited to 35,000 long tons and the draft requirements of Subsection 2.c of this Notice are applicable.

b. The draft of non-self-propelled barges 167.64 meters (550 feet) or more in length may be limited when in the opinion of the Canal Authority such limit is necessary to insure reasonable safety.

c. Upon arrival, the tug will break up the tow and secure the bridle so no part of it extends below the surface of the water.

d. Tows should have the capability of anchoring.

e. All tows will be inspected before being scheduled for transit. **For safety reasons and to ensure that important details are not overlooked, inspections will be performed during day light hours, preferably in the inner harbor.**

- f.** Agents, operators and/or owners will be responsible to make any required alterations or additions to equipment or stowage.
- g.** Boarding facilities will comply with Regulation No. 17, Chapter V, International Convention for Safety of Life at Sea (SOLAS). For tows with freeboards of 9 meters (30 feet) or more, this also includes provisions for a nine-meter rig as described in paragraph 10.f (2) of this Notice.
- h.** There must be a clear passage free of obstructions from the boarding facility to all working areas; otherwise, catwalks with handrails and steps must be provided. **Figure 5** (p. 42) is a sketch of a catwalk and ladder acceptable to the Authority.
- i.** The working area near chocks and bitts on all dead tows must be clear of obstructions and fitted with safety rails or lines at the vessel's sides.
- j.** Tows must provide a pilot shelter with a clear view forward on the center line, about midway between the bow and stern. This shelter may be permanent or portable, but must protect the pilot from the elements. All tows with beam in excess of 24.38 meters (80 feet) shall provide pilot shelters at the extreme beams from which the pilots may readily view the vessel's sides.
- k.** Dead tows must be equipped with the chocks and bitts as set forth in the *ACP Navigation Regulations, Articles 59 and 60*.
- l.** Tows must provide mooring and heaving lines in good condition, and have mooring arrangements and bitts or cleats for securing tugs that do not interfere with those chocks and bitts required for locomotive wires.
- m.** All barges will be fitted so that a pusher tug can be secured with its stem held firmly to the centerline of the barge. Pushing tugs are to be equipped with wire cable snubbers and springs.
- n.** Barges with poor visibility forward will be assigned additional tug assistance for their transit. The commercial tug may be placed in the notch or on a hawser at the discretion of the Transit Operations Division Manager. The determination of what constitutes poor visibility will be made by the Transit Operations Division Manager. The suitability of additional commercial tugs used in the transit will also be determined by the Transit Operations Division Manager.
- o.** Riding crews must be provided in sufficient numbers, as required by the Transit Operations Division Manager, to safely handle tugboat lines and boarding ladders, and to assist in mooring. While underway in Canal waters, anchors shall be manned and ready to be dropped in case of emergency.
- p.** Agents, operators and owners of dead tows are urged to contact the Transit Operations Division Manager, as early as possible, but not later than 48 hours prior to ETA, so that particular requirements essential to planned transits can be met without delay.

6. Vessels Requiring Towing Services

a. Vessels arriving at either Panama Canal entrances having a mean draft in excess of the allowable draft under the Load Line Regulations for the tropical zone applicable (as determined by the American Bureau of Shipping, Lloyd's Register, or other acceptable certifying agency) are required to use the services of one or more ACP tugboats. These towing services will be required in the following Canal areas:

- (a) From Buoys 1 and 2 in the Pacific entrance channel to Gamboa Reach, and vice versa.
- (b) From the north end of Gatun Locks to Buoy 3 in the Atlantic Entrance Channel, and vice versa.

b. In cases where the overdraft is negligible, the assignment of one or more towboats may be waived at the discretion of the Canal Operations Captain or his designee.

c. The following conditions require that vessels be towed through the entire Canal, and the masters shall report these conditions and request the towing services:

- (a) Vessels without mechanical motive power;
- (b) Vessels with disabled machinery or bad steering, and
- (c) Vessels liable to become unmanageable for any other reason.

d. In addition, ACP authorities may require vessels to make use of one or more towboats through Gaillard Cut, on the approaches to the locks, or in any other part of the Canal, when, in their judgment, such action is necessary to ensure reasonable safety to the vessel and/or the Canal and its appurtenances.

e. The towing services in all of the above cases shall be chargeable to the vessel.

7. Deck Load Cargo

a. As provided in the *ACP Navigation Regulations, Articles 72 and 73*, a vessel carrying a deck load shall have it so stowed as to be sufficiently clear to provide safe and clean, working space around all chocks, bits, and other gear used in transiting and so arranged as to not obstruct any direct lead from chock to bits.

b. Deck cargo shall be so stowed to provide safe passage to and from necessary working areas. If access to working spaces is necessary over a deck load, as with lumber, a catwalk will normally be required, unless a leveled, continuous surface free of encumbrances such as lashings is already provided. When catwalks are required they shall be at least 91.5 cm (3 feet) in width and provided with adequate guard rails. Where the deck cargo is sufficiently level for gangway purposes without a catwalk, the guard rails, or life lines, spaced not more than 30.5 cm (12 inches) apart vertically, must be provided on each side of the deck cargo to a height of at least 1.20 meters (4 feet) above the cargo.

c. If deck access is provided on deck adjacent to deck cargo, a leveled continuous passage at least 91.5 cm (3 feet) in width shall be provided. This access shall be

unencumbered by shoring, lashings or other obstacles deemed hazardous to normal passage. Height over passageway may not be less than 2.134 meters (7 feet).

d. When personnel are required to traverse over deck cargo, ladders adequate for safe access must be provided between the deck and top of deck cargo. Such ladder must be provided with guardrails or safety lines as previously described for catwalks.

e. Deck cargo shall be stowed securely to prevent any shifting or displacement during access to working spaces by personnel.

f. Vessels may transit the Panama Locks with deck cargo protruding over one side only, not to exceed 4.572 meters (15 feet); but the maximum beam, including protrusions, must not exceed 25.90 meters (85 feet).

g. The transit of vessels with protrusions, that due to its dimensions can only transit the Neopanamax Locks, will be evaluated for approval on a case-by-case basis.

h. An adequate bulwark or railing shall be provided between deck cargo and the ship's side.

i. All sharp edges and projections on deck cargo adjacent to normal accesses shall be adequately protected to prevent injury to personnel.

j. Sufficient lighting shall be provided by the vessel to illuminate deck accesses and working spaces during hours of darkness.

k. Figure 5 below shows sketches of a catwalk and ladder acceptable to the Authority.

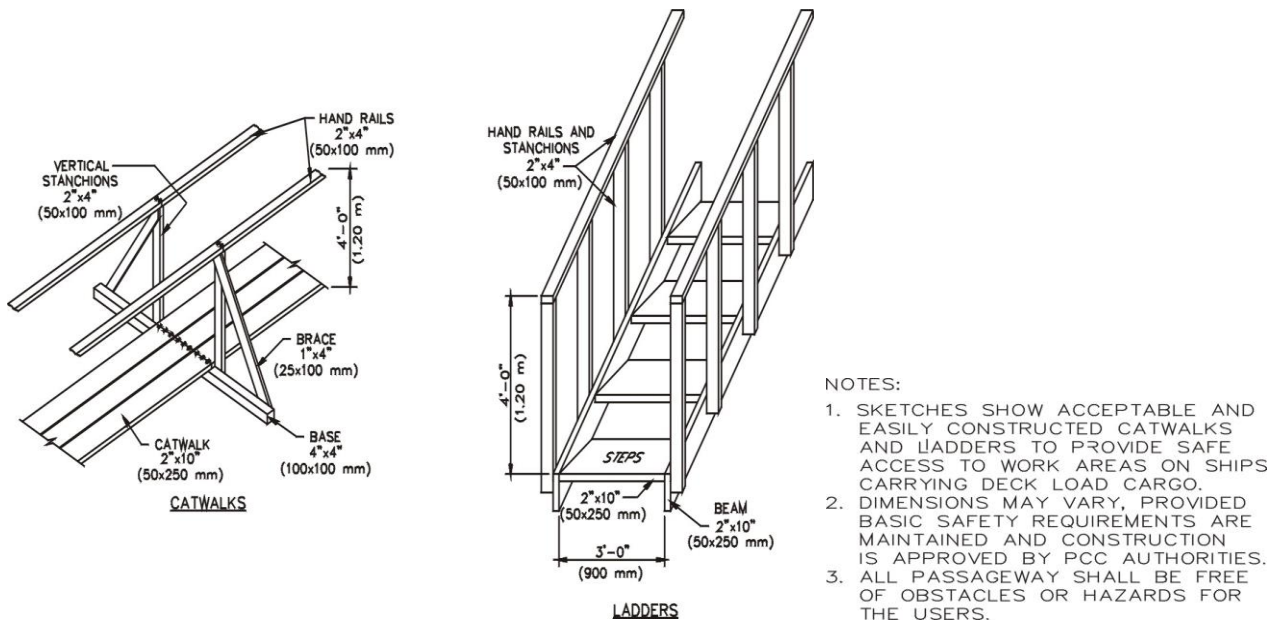

FIGURE 5 - Catwalk and Ladder Sketches

8. Construction, Number and Location of Chocks and Bitts

a. *Vessels Transiting the Panamax Locks* - A vessel passing through the Panamax locks shall normally be assisted by electric locomotives using steel towing wires. At the discretion of the Transit Operations Division Manager, certain vessels, usually those under 38.10 meters (125 feet) in length, may be handled with their own lines either against the lock wall or from both walls in the center of the chamber. Transiting vessels are required to have chocks and bitts as follows:

(1) All chocks for towing wires shall be of heavy closed construction and shall have a convex bearing surface with a radius of not less than 180 mm (7 inches). The convex surface shall extend so that a wire from the bitt, or from the locks locomotive through the chock, shall be tangent to the 180 mm (7 inches) radius at any angle up to 90 degrees with respect to a straight line through the chock.

(2) No part of the vessel which may be contacted by the towing wires, at any angle, shall have less than a 180 mm (7 inches) radius.

(3) Chocks designated as single chocks shall have a throat opening of not less than 650 square cm (100 square inches) in area — preferred dimensions are 305 mm x 230 mm (12 x 9 inches) — and shall be capable of withstanding a SWL of 45.36 tons (100,000 pounds) on a towing wire from any direction.

(4) Chocks designated as double chocks shall have a throat opening of not less than 900 square cm (140 square inches) in area — preferred dimensions are 355 mm x 255 mm (14 x 10 inches) — and shall be capable of withstanding a SWL of 64 tons (140,000 pounds) on the towing wires from any direction.

(5) Use of existing roller chocks is permissible provided they are not less than 15 meters (49 feet) above the waterline at the vessel's maximum Panama Canal draft and provided they are in good condition, meet all of the requirements for solid chocks as specified in paragraphs 8.a(1), 8.a(2), 8.a(3) and 8.a(4) of this section, as the case may be, and are so fitted that transition from the rollers to the chock body will prevent damage to towing wires. However, roller chocks are not accepted in plans of new constructions which are submitted for approval as indicated in subsection 2.h (Approval of Plans) of this Notice.

(6) Each single chock shall have an accompanying bitt — preferred diameter of 356 mm (14 inches) — capable of withstanding a SWL of 45.36 tons (100,000 pounds).

(7) Each double chock located at the stem and the stern, in accordance with paragraph 8.a(8) of this section, shall have two pairs of accompanying heavy bitts with each bitt of each pair — preferred diameter of 406 mm (16 inches) — capable of withstanding the stress caused by a SWL of 64 tons (140,000 pounds). Other double chocks shall have a pair of accompanying heavy bitts with each bitt capable of withstanding a SWL of 64 tons (140,000 pounds).

(8) All vessels, except those not requiring locomotives, shall be fitted with a double chock set athwartships right in the stem and another double chock set athwartships right in the stern, except that on vessels of less than 22.86 meters (75 feet) in beam, two single chocks may be substituted for each double chock required by this subsection; on vessels of over

22.86 meters (75 feet) in beam two double chocks may be substituted. If such substitution is made, the chocks shall be placed port and starboard not more than 2.5 meters (8 feet) abaft the stem or 3 meters (10 feet) forward of the stern, provided that these chocks are not more than 3 meters (10 feet) from the center line of the vessel.

(9) Vessels under 60.96 meters (200 feet) in length and less than 15.24 meters (50 feet) in beam shall have a double chock or two single chocks at the stem and stern. If the vessel is equipped with the two single chocks they shall be placed, port and starboard, not more than 2.5 meters (8 feet) abaft the stem or 3 meters (10 feet) forward of the stern, and not more than 3 meters (10 feet) off the center line (see Figure 6 on p. 46).

(10) Vessels from 60.96 meters to 121.92 meters (200 up to 400 feet) in length and not exceeding 22.86 meters (75 feet) in beam shall have a double chock at the stem and at the stern or two single chocks at the bow and stern, port and starboard, not more than 2.5 meters (8 feet) abaft the stem or 10 feet (3 meters) forward of the stern and not more than 3 meters (10 feet) off the center line and shall have two additional single chocks, port and starboard, 9 to 16 meters (30 to 50 feet) abaft the stem and 9 to 16 meters (30 to 50 feet) forward of the stern (see Figure 6 on p. 46).

(11) Vessels from 121.92 meters to 173.74 meters (400 up to 570 feet) long and not more than 22.86 meters (75 feet) in beam shall have a double chock at the stem and stern or two single chocks at the bow and stern, port and starboard, not more than 2.5 meters (8 feet) abaft the stem or 3 meters (10 feet) forward of the stern and not more than 3 meters (10 feet) off the center line. In addition, these vessels shall have a double chock, port and starboard, 12 meters to 16 meters (40 to 50 feet) abaft the stem, a single chock port and starboard, 24 meters to 28 meters (80 to 90 feet) abaft the stem, and a single chock, port and starboard, 12 meters to 16 meters (40 to 50 feet) forward of the stern (see Figure 6).

(12) Vessels over 173.74 meters (570 feet) long or 22.86 meters (75 feet) in beam or over shall have a double chock at the stem and stern or two double chocks at the bow and stern, port and starboard, not more than 2.5 meters (8 feet) abaft the stem or 3 meters (10 feet) forward of the stern and not more than 3 meters (10 feet) off the center line. In addition, these vessels shall have a double chock, port and starboard, 12 to 16 meters (40 to 50 feet) abaft the stem; a single chock, port and starboard, 24 to 28 meters (80 to 90 feet) abaft the stem; a double chock, port and starboard, 12 to 16 meters (40 to 50 feet) forward of the stern and a single chock, port and starboard, 24 meters to 28 meters (80 to 90 feet) forward of the stern. On vessels over 274.32 meters (900 feet) in length with maximum beam of 27.73 meters (91 feet) or more extending to the stern, the double chocks required on port and starboard, 12 to 16 meters (40 to 50 feet) forward of the stern, shall be located no less than 13 meters (42.65 feet) above the waterline at the maximum Panama Canal fresh water draft of the vessel.

(13) All vessels with a maximum beam of 27.73 meters (91 feet) or more, in addition to the double chock at the stern, which is required by Paragraph 8.a (12), above, shall have two single chocks on the stern. One chock shall be to port of the centerline and one chock shall be to starboard of the centerline. The single chocks shall be symmetrically spaced not less than 3 meters (10 feet) nor more than 6 meters (20 feet) from the centerline.

(14) Vessels with large flared bows, pronounced counters astern or unusually high freeboard, such as container vessels or vehicle carriers, will be required to provide single closed chocks located further aft/forward, respectively, than those required for SET2/SET3 in Figure 6 and in Paragraph 8.a (12) for correct positioning of assisting tugs, or may be required to fit recessed tug bollards into the hull so that tugs can work without coming in contact with the bow flare or without requiring extra- long lines and/or inefficient leads (see Figure 6).

(15) Where recessed hull bitts are installed in the hull, they shall be installed not less than 3.7 meters (12 feet) and not more than 4.6 meters (15 feet) above the vessel's waterline. Vessels that have an appreciable variation in draft may be required to install two sets of recessed hull bitts so that one bitt is located over the other bitt. Also, the recessed hull bitts are to be installed in the hull as far forward as possible, both port and starboard sides, where the bow flare does not exceed 25 degrees as measured from the vertical line of the vessel's side. This position may require locating the chocks and bitts further aft than the 24 to 28 meters (80 to 90 feet) abaft the stem as in paragraph 8.a (11). This position will allow ACP tugboats to work safely under the bow flare without the tugboats' mast or pilothouse coming in contact with the vessel's hull.

(16) A vessel not requiring locomotives shall have a chock arrangement similar to that described in paragraph 8.a (9), except that the chocks need only be single chocks or, if approved by the Canal Authority, of lesser strength.

(17) Any vessel that fails to meet these requirements may be denied transit. If the Vice President for Transit Business or his representative decides that the vessel can be handled without undue danger to equipment or to personnel, notwithstanding her failure to comply with other requirements of this section, the vessel may be allowed to transit after executing a release. The master of the vessel must sign an undertaking for the vessel, her owners, operators or any other persons having any interest in her, and for himself, releasing the Authority from and indemnifying it against any loss, damage or liability incurred by the Canal Authority to the extent and in the proportion that such failure to meet the requirements of this section proximately causes or contributes to the casualty and resulting damages.

(18) All new vessels are expected to comply with all current vessel requirements. Pre-existing vessels are granted a waiver for one round trip or for one year from the date of the waiver, whichever comes first. Certain tank vessels, and other vessels that prove to the satisfaction of the Authority that the work necessary to fit the chocks on the stern cannot be safely performed while at dockside, will be provided with a waiver extending until the next yard overhaul. Vessels with ACP approved recessed bitt on the stern may, upon written application, be exempted from this requirement.

(19) Adequate working space shall be provided on deck areas adjacent to winches, capstans, chocks, bitts and fairleads and along the path of mooring lines at least 91.5 cm (3 feet) in width. This space shall be unencumbered by trash, shoring, lashings or other obstacles deemed hazardous to normal passage or work by line handlers. Height over these areas may not be less than 2.134 meters (7 feet). The working space provided along the path of the mooring lines and beside the bitts must be sufficient so that three linehandlers can pull the lines aboard without using winches or capstans.

(20) Access to/from the mooring/conning stations for Panama Canal personnel via vertical ladders, the climb shall not exceed a continuous height of 9.1 meters (30 feet), otherwise, staggered ladders with intermediate platforms shall be provided. Ladder rungs shall have efficient non-slip surface, a minimum stepping width of 406 mm (16 inches) and be equally spaced apart not less than 275 mm (11 inches) nor more than 305 mm (12 inches). Ladder stringers should be provided on both sides of the ladder shall be constructed of pipes with preferred nominal diameter of 40 mm (1.5 inches). Flat bar stringers should be avoided. For several runs of vertical ladders, the stringers shall extend 1.07 meters (42 inches) above landings or intermediate platforms. Top rung of ladders used to access a deck, work platform, building roof, or top of a tank by stepping through the ladder to a walking or standing surface, should be flush with that surface. Rungs shall be round - 25 mm (1 inch) diameter; or square bar oriented edge up - 25 mm (1 inch) x 25 mm (1 inch).

(21) Handles shall be provided where a vertical ladder comes up to a manhole/hatch opening from the deck below where the ladder does not extend through the platform/hatch. Handles should be also be accessibly located at all stages during climbing or traversing through access hatches. Horizontal separation from stringer shall be 225 mm (9 inches) minimum up to 450 mm (18 inches) maximum. Handles or handgrabs shall be suitably located to provide for safe ascending and descending, while stepping onto or from ladders, individual ladder rungs or steps and through hatches or lightening holes. Handles or handgrabs should be provided for ladder not extending through Platforms to a height of handles 1000 mm (39.5 inches), Round Bar Diameter 25 mm (1 inch).

(22) For further information contact the Transit Operations Division Manager.

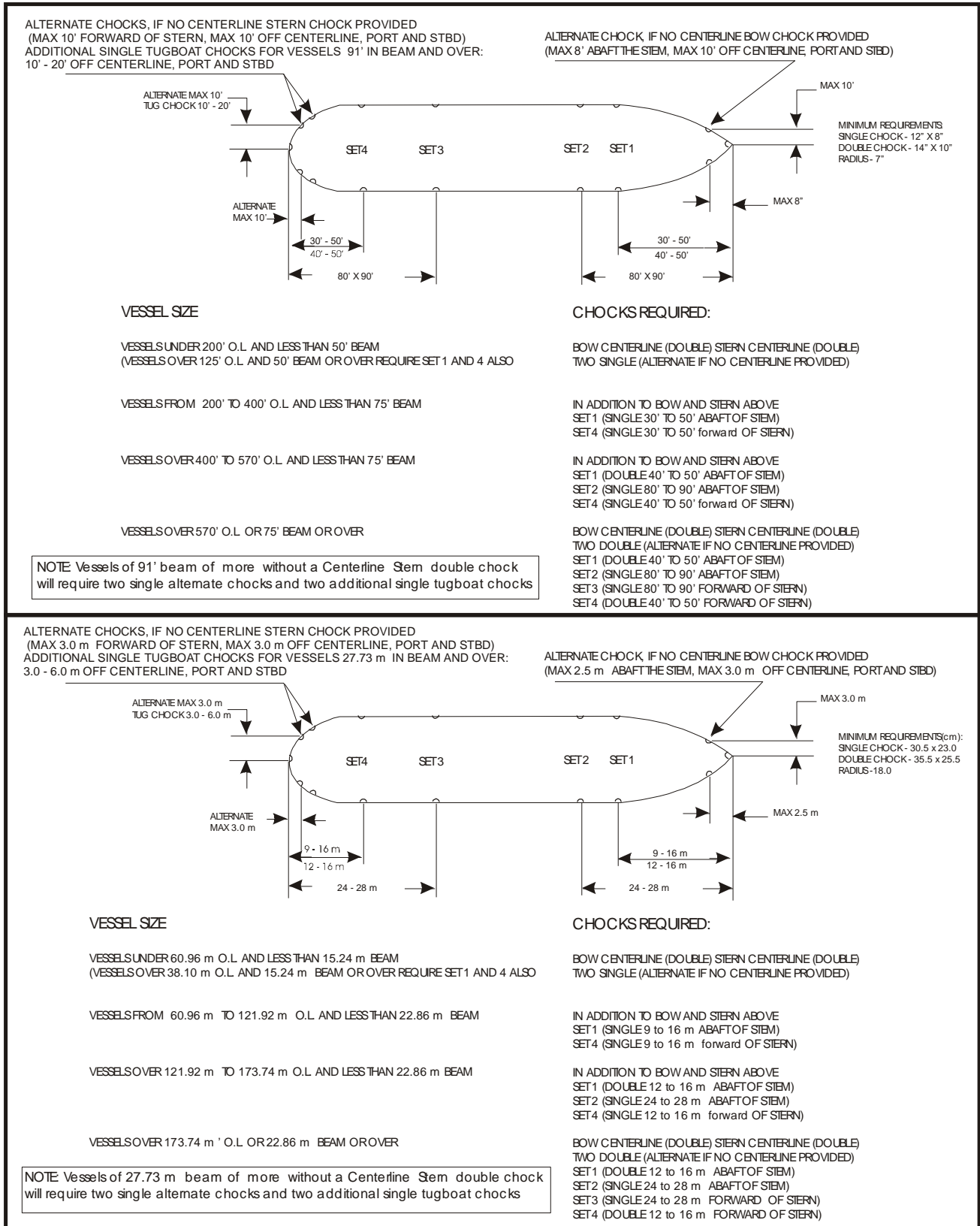

FIGURE 6 – Location of Chocks and Bits (Panamax)

b. Neopanamax and Panamax Plus Vessels

(1) Mooring requirements, as stated in Subsection 8.a of this Notice, will remain unchanged for *Panamax* vessels. For *Panamax Plus* and *Neopanamax* vessels, mooring requirements will be as stated in the updated Notice except as required herein. Namely, the chocks and bitts will be used by ACP tugs assisting vessels through the new locks, as well as for mooring vessels inside the locks. Vessels over 294.13 meters (965 feet) long or over 32.31 meters (106 feet) in beam shall have a double chock (mooring) at the stem, and stern or one double chock (mooring) at the bow and stern, port and starboard, not more than 2.5 meters (8.2 feet) abaft the stem or 3 meters (9.84 feet) forward of the stern and not more than 3 meters (9.84 feet) off the center line. In addition, these vessels shall have double chocks (mooring), port and starboard, 2.5 to 16 meters (8.2 to 52.48 feet) abaft the stem and 3 to 16 meters (9.84 to 52.48 feet) forward of the stern, SET1 and SET4, respectively. (See **Figure 7** below.)

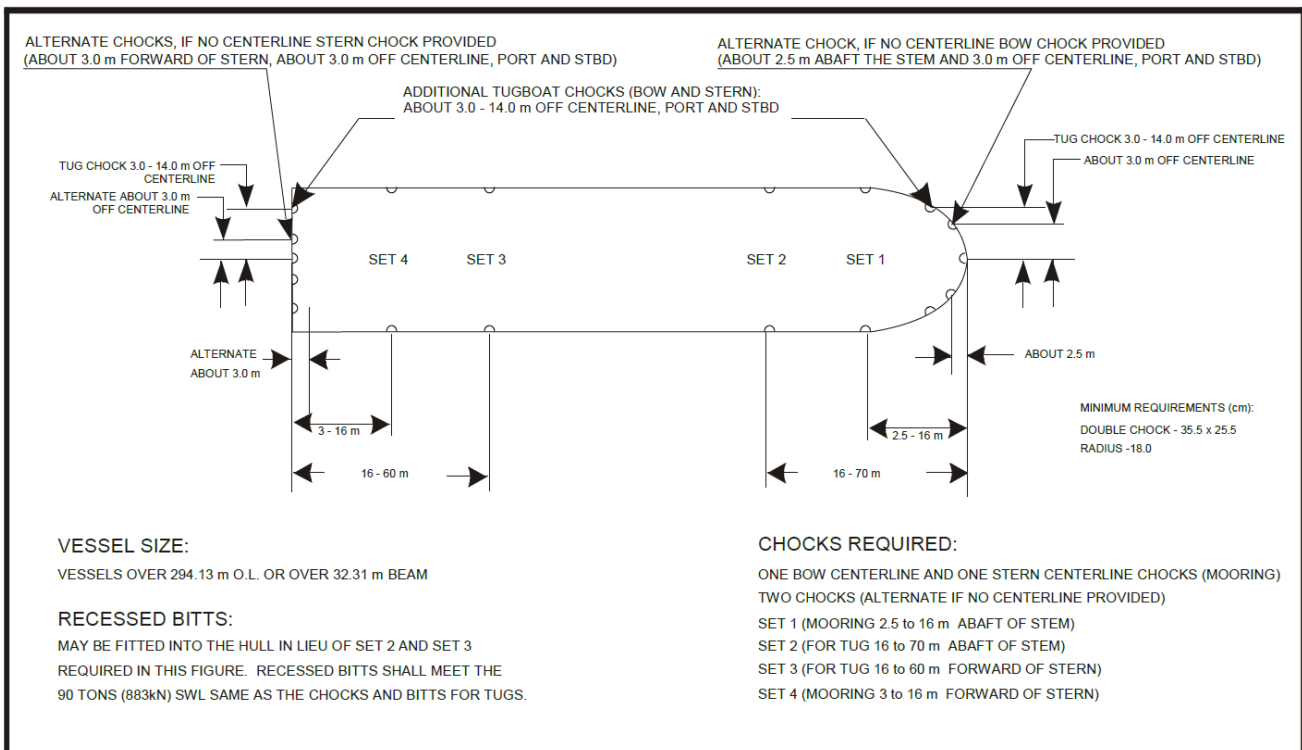

FIGURE 7 – Location of Chocks and Bitts (*Neopanamax* and *Panamax Plus*)

(2) All chocks for the *Panamax Plus* and *Neopanamax* vessels shall be double chocks and shall have a throat opening area of not less than 900 square centimeters (preferred dimensions are 355 x 255 millimeters / 1.18 x 0.85 feet) and shall be capable of withstanding a SWL of 90 tons (883kN) in towing operations and a minimum SWL of 64 tons (628 kN) in mooring operations from any direction, in accordance with Paragraph 8.a (5) of this Notice.

(3) *Neopanamax* and *Panamax Plus* vessels shall have additional tugboat chocks fitted symmetrically at the bow and stern about 3.0 - 14.0 meters (9.84 - 45.92 feet) off centerline,

port and starboard sides. In the bow these chocks are to be placed inboard or just above the anchors for safe tug assist operations. Each of these double chocks shall be served by one pair of accompanying heavy bitts with a preferred diameter of 500 mm (19.685 inches), and each bitt shall be capable of withstanding the stress caused by a SWL of 90 tons (883kN). All other towing chock locations, namely SET2 and SET3, will also require one pair of heavy bitts with each bitt capable of withstanding a SWL of 90 tons (883kN). The rest of the chock locations for use in mooring operations shall be accompanied by one pair of heavy bitts meeting the minimum SWL of 64 tons (628 kN).

(4) Vessels with large flared bows, pronounced counters or unusually high freeboards, such as LNG carriers, container vessels, cruise vessels or vehicle carriers, will be required to provide closed chocks located further aft/forward, respectively, than those required for SET2/SET3 above and in Paragraph 8.a.(14) of this Notice, for correct positioning of assisting tugs. These vessels may be required to fit recessed tug bollards into the hull in lieu of the chocks detailed in this paragraph so that tugs can work without coming in contact with the flare or counter and without requiring extra-long lines and/or inefficient leads. Recessed bitts shall meet the 90 tons (883kN) SWL required above.

(5) All vessels wishing to transit the new locks will be required to have mooring winches in operation and fitted with manila or synthetic mooring lines before every transit to be used during mooring operations at the new locks. Noting that "Wire ropes and ropes composed of both wire and fiber or filaments, are not acceptable for Canal operations and shall not be used," as indicated in the last sentence of Paragraph 9.a; and that, similar to the ACP current practice for temporarily mooring of vessels inside the chambers during relay operations in the actual locks, the normal procedure in the new locks will be to use the manila or synthetic mooring lines from the vessel's winch drums. The mooring fittings that will be used for mooring at the locks will be the chocks located at the bow/stern centerline or alternate, SET1 and SET4.

(6) The use of existing roller chocks (open type) on vessels will be evaluated for approval during transit, upon request, on a case-by-case basis, provided they are located not less than 16.24 meters (53.267 feet) above the waterline at the vessel's maximum Panama Canal draft, are in good condition, meet all requirements for closed chocks, as specified above, and are fitted so that the transition from the rollers to the body of the chock prevents damage to the mooring lines. The equivalency of the proposed closed roller chocks shall be submitted for review and acceptance by the ACP.

(7) Similar equivalency may be requested for existing universal roller fairleads (closed type) located below the 16.24 meters (53.267 feet) height, providing the transition from the rollers to the outer frame of the fairlead at side is shown to prevent damage to the mooring lines in upward directions, as well as downward, with structure built at the top similar to that at the bottom, giving the ropes a safe surface on which to chafe and grind under all directions of load. The universal roller fairlead/supporting structure as a unit are to be certified as complying with 64 tons (628 kN) SWL in all directions.

(8) Alternatively, mooring arrangements have been found acceptable showing the use of stand rollers and/or double bollards to redirect the lines from the winch drums to the double chocks (mooring).

Vessels not in compliance with the requirements established in this Notice to Shipping shall be evaluated in order to determine under what conditions, if any, they may be allowed to transit or dock. Vessels that require additional resources due to non-compliance or other deficiencies will be assessed the corresponding charges.

9. Mooring Lines, Anchors and Deck Machinery

a. Vessels are required to have available for immediate use six manila or synthetic mooring lines forward and six aft in good conditions prior to commencing transit. The size and strength suitable for the vessel to dock, moor at a lock approach wall or secure in a lock chamber are the vessel's responsibility. The master shall inform the Boarding Officer whether or not the vessel complies with the above, so that he may advise Maritime Traffic Control Unit. Wire ropes and ropes composed of both wire and fiber or filaments, are not acceptable for Canal operations and shall not be used.

b. Four (4) of the lines on the bow and four (4) of the lines on the stern shall be stowed in winch drums and ready to be used in the procedure. Wires in the drums are not acceptable and must be replaced with manila or synthetic mooring lines before initiating the transit.

c. Each line shall be at least 328 feet (100 m) in length and shall have an eye of at least five feet (1.50 m) spliced in one end. If one of these lines is 656 feet (200 m) or more in length with an eye in each end, it will qualify as two lines for the purpose of this requirement. They shall be in good condition. Non-compliance with this requirement could result in transit delay.

d. Mooring tails attached to the end of HMPE mooring lines are required in order to provide ease of handling as well as the necessary elasticity to absorb the usual dynamic loads generated during mooring and lockage operations. Tails must be properly matched and connected to the specific HMPE line with which they are going to work. The size, material and length of the mooring tails (pennants) shall comply with the requirements by the HMPE line manufacturer. The connecting method between the line and the mooring tail shall be of an adequate size, weight and configuration in order not to affect the ease of handling of the lines.

e. Anchors and deck machinery shall be operational at all times.

f. Automatic tension winches should never be operated in the automatic mode when the ship is in the Neopanamax locks or at the various tie-up stations.

g. Capstans or mooring winches' warping heads used to assist in heaving mooring lines, shall be capable of pulling these lines at a rate of 37 meters (120 feet) per minute. This requirement is applicable to all transiting vessels. The master shall inform the ACP Boarding Officer whether or not the vessel complies with this requirement. Additional Canal deckhands or other resources may be assigned in those cases where the capstans or winches are not working or are with limited capabilities.

h. Anchors shall be retrieved at a rate of not less than 0.15 m/sec (3 minutes per shot).

10. Boarding Facilities

a. The Authority considers proper boarding facilities to be an absolute necessity to ensure the safety of operations personnel and others using these facilities in Canal waters. Poorly constructed, installed, maintained or operated boarding facilities are not acceptable for use in Canal waters. Requirements for boarding facilities are defined in the *ACP Navigation Regulations, Articles 57 and 58*. Vessels with unsafe or inadequate boarding facilities will be required to correct such deficiencies before transiting and lengthy delays may result. **Figure 8** (p. 51), is a pictorial representation of acceptable boarding facilities that comply with Canal standards.

b. Safe boarding facilities should be available through the entire transit for pilots and Canal deckhands. Improper boarding facilities may delay the transit or, if deemed safe by the Authority, may require use of a tug to hold the vessel dead in the water during boarding or disembarking operations. This is considered a vessel deficiency, therefore the tug will be charged to the vessel.

c. Boarding facilities of vessels arriving the Canal shall comply with the requirements shown below, in addition to those indicated in Regulation 23, Chapter V, SOLAS, including all current amendments, annexes and resolutions.

d. *General*

(1) All arrangements used for ACP personnel or other transfers shall efficiently fulfill their purpose of safely enabling embarking and disembarking. The appliances shall be kept clean, properly maintained and stowed and shall be regularly inspected to ensure that they are safe to use. They shall be used solely for the embarkation and disembarkation of personnel.

(2) The rigging of the transfer arrangements and the embarkation and disembarkation of ACP personnel or others shall be supervised by a responsible officer with means of communication with the navigation bridge, who shall also arrange for the escort of the pilot by a safe route to and from the navigation bridge, and the deckhands to and from their designated work stations. Personnel engaged in rigging and operating any mechanical equipment shall be instructed in the safe procedures to be adopted. All boarding equipment shall be tested in operating position by the vessel's personnel prior to use by Authority personnel.

(3) Reference in this regulation to an accommodation ladder includes a sloping ladder used as part of the pilot transfer arrangement.

e. *Transfer Arrangements*

(1) Arrangements shall be provided to enable ACP personnel or others to embark and disembark safely on either side of the ship. All vessels shall have, weather permitting, both an accommodation ladder and a pilot ladder rigged and ready for use upon arrival in Canal waters.

(2) When it is intended to embark and disembark ACP personnel or others by means of the accommodation ladder or other equally safe and convenient means in conjunction with a

pilot ladder, the ship shall carry such equipment on each side, unless the equipment is capable of being transferred for use on either side.

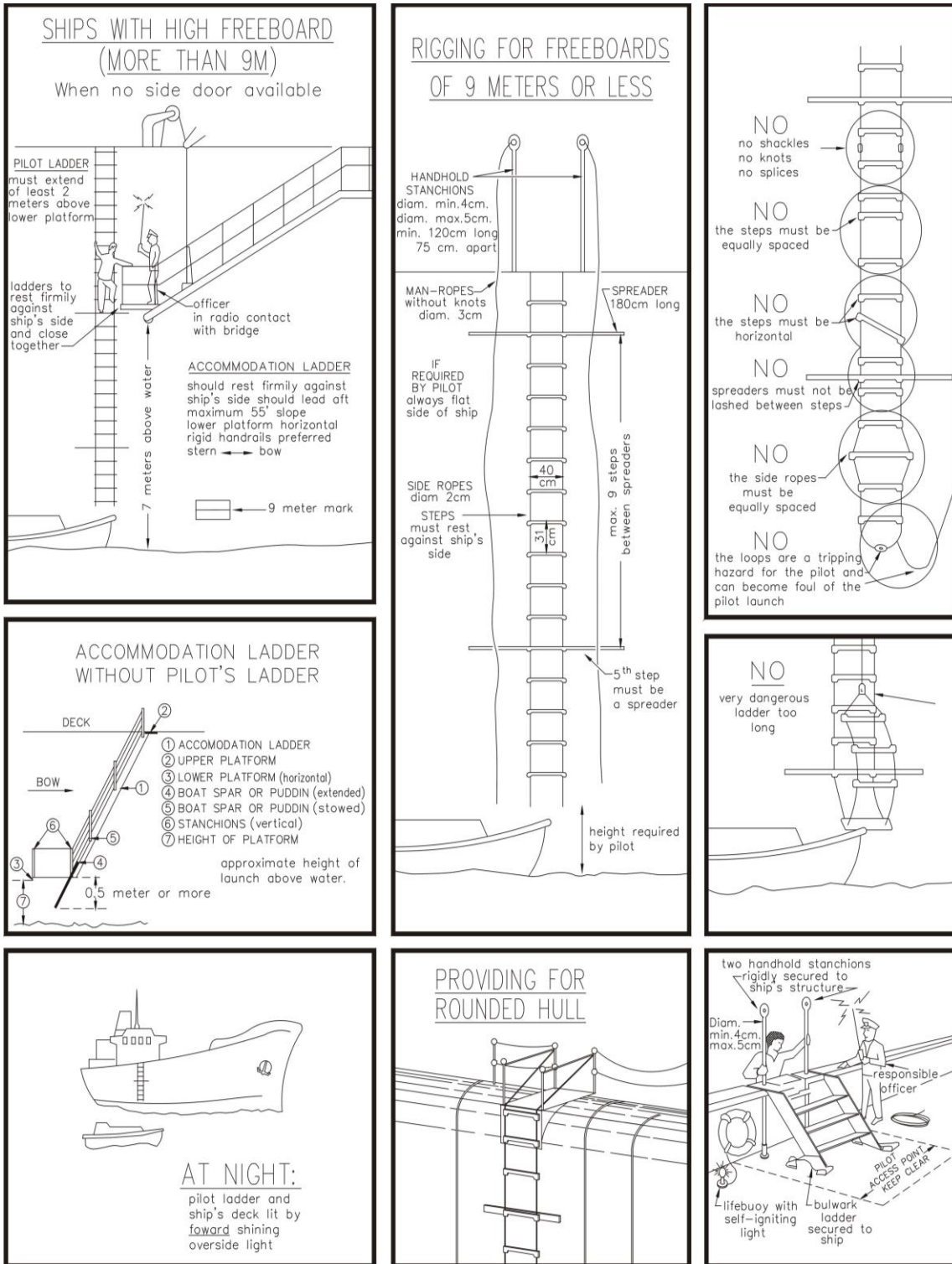

FIGURE 8 – Panama Canal Required Boarding Arrangements

f. Safe and convenient access to, and egress from, the ship shall be provided by both a pilot ladder and an accommodation ladder. Mechanical pilot hoists are not accepted. Other boarding devices must be approved by the Authority and may be used at the option of the pilot or line handlers.

(1) *Pilot ladders*

(a) The pilot ladder shall be certified by the manufacturer as complying with this regulation or with an international standard acceptable to the ACP. Ladders shall be inspected in accordance with SOLAS regulations I/6, 7 and 8.

(b) All pilot ladders used for pilot transfer shall be clearly identified with tags or other permanent marking so as to enable identification of each appliance for the purposes of survey, inspection and record keeping. A record shall be kept on the ship as to the date the identified ladder is placed into service and any repairs effected.

(c) The ladder shall be safe, convenient and efficient for the purpose of enabling the pilots to embark and disembark safely, kept clean and in good order and may be used by officials and other persons while a ship is arriving or leaving a port.

(d) The ladder shall require a climb of not less than 1.5 meters (5 feet) and not more than 9 meters (30 feet) above the surface of the water.

(e) The ladder shall be so positioned that it is clear from any possible discharges from the ship, that it is within the parallel mid-body length of the ship and, as far as is practicable, within the mid-ship half-length of the ship.

(f) Each step shall rest firmly against the ship's side; where constructional features, such as rubbing bands, would prevent the implementation of this provision, special arrangements shall be made to the satisfaction of the Authority to ensure that persons are able to embark and disembark safely.

(g) A single length of ladder shall be used capable of reaching the water from the point of access to, or egress from, the ship; in providing for this, due allowance shall be made for all conditions of loading and trim of the ship and for an adverse list of 15 degrees. Whenever the distance from sea level to the point of access to the ship is more than 9 meters (30 feet), access from the pilot ladder to the ship shall be by means of an accommodation ladder or other equally safe and convenient means.

(h) The securing strong points, shackles and securing ropes shall be at least as strong as the side ropes.

(i) The steps of the pilot ladder shall comply with the following requirements:

- If made of hardwood, they should be made in one piece, free of knots or other defects. If made of material other than hardwood, they should be of equivalent strength, stiffness and durability to the satisfaction of the Authority.

- The four lowest steps may be made of rubber of sufficient strength and stiffness or other material to the satisfaction of the Authority.

- Steps shall have an efficient non-slip surface, and shall not be painted with an opaque color or high gloss paint. The grain and character of the step shall be visible in order that any cracks or defects may be readily visible to the person using the ladder.

- Should have not less than 406 mm (16 inches) between the inside surfaces of the side ropes. Steps should be not less than 115 mm (4-1/2 inches) wide, and 25 mm (1 inch) in depth, excluding any non-slip device or grooving.

- Should be equally spaced not less than 305 mm (12 inches) nor more than 380 mm (15 inches) apart and be secured in such a manner that each will remain horizontal.

(j) No pilot ladder shall have more than two replacement steps which are secured in position by a method different from that used in the original construction of the ladder, and any steps so secured shall be replaced as soon as reasonably practicable by steps secured at position by the method used in the original construction of the ladder. When any replacement step secured to the side ropes of the ladder by means of grooves in the sides of the steps, such grooves shall be in the longer sides of the steps.

(k) Pilot ladders with more than five steps should have spreader steps not less than 1.8 meters (6 feet) long provided at such intervals as will prevent the pilot ladder from twisting. Such spreader steps or battens shall be made of the same material and construction as the other ladders steps. The lowest spreader step shall be on the fifth step from the bottom of the ladder and the interval between any spreader step and the next shall not exceed nine steps.

(l) The side ropes of the ladder shall consist of two uncovered ropes not less than 20 mm (3/4 inch) in diameter on each side. Each rope shall be continuous with no joints below the top step. Two manropes properly secured to the ship and between 28 mm (1 inch) and 32 mm (1.3 inch) in diameter shall be ready for immediate use if required by the pilot.

(m) Man-ropes shall be fixed at the rope end to the ring plate fixed on deck and shall be ready for use when the pilot disembarks, or upon request from the pilot approaching to board (the manropes shall reach the height of the stanchions or bulwarks at the point of access to the deck before terminating at the ring plate on deck).

(n) Side ropes shall be made of manila or other material of equivalent strength, durability and grip that has been protected against actinic degradation and is satisfactory to the Authority.

(o) A life buoy equipped with a self-igniting light should be kept at hand ready for use, as should a heaving line. Life buoys should not be attached to the ship.

(p) Lighting should be provided such that both the pilot ladder over side and the position where any person embarks or disembarks on the ship are adequately lit.

(2) *Accommodation ladders*

(a) Accommodation ladders should be sited leading aft, that is, with the lower platform at the after end. Means shall be provided to secure the lower platform of the accommodation ladder to the ship's side, so as to ensure that the lower end of the accommodation ladder and the lower platform are held firmly against the ship's side. A pilot ladder complying with

the provisions of Paragraph 10.f (1) shall always be kept on deck adjacent to the accommodation ladder and available for immediate use.

(b) The lower platform of the accommodation ladder shall be kept in a horizontal position when in use, with the boat spar extended, and it should be held at the same height above the water as the deck of the pilot boat. Intermediate platforms, if so fitted, shall be self-leveling. Treads and steps of the accommodation ladder should be so designed that an adequate a safe foothold is provided at all operating angles.

(c) The ladder and platforms shall have vertical safety stanchions and rails or lines equipped and rigged on both sides. If hand ropes are used, they should be tight and properly secured. The vertical space between the handrail or hand rope and the stringers of the ladder should be securely fenced.

(d) The length of an accommodation ladder used in combination with a pilot ladder as a nine-meter rig should be sufficient to ensure that its angle of slope doesn't exceed 55 degrees. The pilot ladder should be rigged immediately adjacent to the lower platform of the accommodation ladder and be secured at the edge of the lower platform with the pilot ladder hanging vertically. The pilot ladder should extend at least 2 meters (6 feet 8 inches) above the lower platform and shall rest firmly against the ship's side within the parallel mid-body of the ship and, as far as is practicable, within the mid-ship half-length and clear of all discharges. The lower platform must be held at a level to allow for the height of the launch deck, plus the height of a person standing on the deck, plus the rise and fall due to swell; normally, 7 meters (23 feet) above the water is sufficient.

(e) Lighting shall be provided at night such that the full length of the ladder is adequately lit.

(f) If a trap door is fitted in the lower platform of a combination ladder arrangement to allow access from and to the pilot ladder, the aperture should not be less than 750 mm x 750 mm (30 inches x 30 inches) and of a design approved by the Authority. In this case the after part of the lower platform should also be fenced as specified in Paragraph 10.f (2) (c), and the pilot ladder should extend above the lower platform at least 2 meters (6 feet 8 inches). The aperture on the lower platform must be open to the side of the vessel's hull to allow the pilot ladder to lay flat against the hull.

(g) Accommodation ladders, together with any suspension arrangements or attachments fitted and intended for use in the Canal, must be arranged to the satisfaction of the Authority. **Note:** *Subsection 10.f.(3), Mechanical pilot hoists, was eliminated in compliance with changes made to Regulation 23, Chapter V, International Convention for Safety of Life at Sea (SOLAS).*

(3) Ship side doors

Ship side doors used for pilot transfer shall not open outward. The point of ingress or egress must be no less than 1.5 meters (5 feet) above the surface of the water. The opening used for embarking or disembarking shall not be less than 1.5 meters (5 feet) wide and 2.2 meters (7.2 feet) tall.

(4) Access to deck

(a) Means shall be provided to ensure safe and convenient and unobstructed passage for any person embarking or disembarking, between the head of the pilot ladder, or of any accommodation ladder or other appliance provided, and the vessel's deck.

(b) Where such passage is by means of a gateway in the rail or bulwark, adequate handholds or stanchions shall be provided.

(c) If passage is over the bulwark, a bulwark ladder shall be provided. The bulwark ladder shall be securely attached to the deck or bulwark to prevent overturning. Two handhold stanchions shall be fitted at the point of embarking or disembarking from the ship on each side.

(d) Handholds and handhold stanchions should not extend beyond the hull of the ship and should be free of protrusions such as loops, welded bars or pad eyes, and should be designed to allow the human hand to grasp any portion and slide up and down, as necessary, without removing the hand or releasing the grip. Handholds and stanchions should be not less than 70 cm (2 feet 3 inches) and no more than 80 cm (2 feet 7 inches) apart. Each stanchion shall be rigidly secured to the ship's structure at or near its base and also at a higher point. Handholds and stanchions shall not be less than 32 mm (1-1/4 inches) and no more than 50 mm (2 inches) in diameter, and shall extend not less than 1.2 meters (4 feet) above the top of the bulwarks or point of ingress. Stanchions or handrails should not be attached to the bulwark ladder.

(e) Adequate lighting shall be provided to illuminate the position on deck where a person embarks or disembarks.

11. Double Hull Requirement for Oil Tankers

All crude oil tankers, combination carriers, product carriers, gas carriers, NLS tankers, and chemical tankers transporting oil (as defined in Regulation 1 of Annex I, MARPOL) shall meet the double hull and double bottom requirements set forth in Regulation 19 of Annex I, MARPOL. Transport of oil in completely single hull vessels, single side vessels, or single bottom vessels is not allowed in Panama Canal waters.

12. Admeasurement System for Full Container Vessels

The ACP admeasurement system for full container vessels reflects the international standard for a container (20-foot equivalent unit, TEU, whose external length, width and height measurements are 20'x 8'x 8.5'.) This measurement considers the full container carrying capacity of vessels (above and below deck), taking into account the visibility limitation imposed by the Panama Canal.

To determine TEU allowance below deck, TEU allowance above deck, NTT, TTE and TTL as may be applicable, the following table will be used:

CONTAINER SIZE	RATIO(FT³)	EQUIVALENCY
20' x 8' x 8.5'	1,360/1,360	1.00 TEUS
20' x 8' x 9.5'	1,520/1,360	1.12 TEUS
40' x 8' x 8.5'	2,720/1,360	2.00 TEUS
40' x 8' x 9.5'	3,040/1,360	2.24 TEUS
45' x 8' x 9.5'	3,420/1,360	2.51 TEUS
48' x 8' x 9.5'	3,648/1,360	2.68 TEUS
54' x 8' x 9.5'	4,104/1,360	3.02 TEUS

Any container whose size is not listed in the preceding table shall obtain its equivalence using the same method of calculation.

ACP considers containers as cargo regardless of their contents or lack thereof. Containers that are used to transport generators, lashing gears, or that have been modified, will continue to be classified as containers and will be charged as such. A container utilized to fulfill certain tasks, other than carrying cargo, will be considered as part of the vessel's superstructure if the following criteria are met:

- Be securely welded or connected to the deck or to the vessel's structure.
- Provide ACP Admeasurement Unit with a copy of an International Tonnage Certificate (ITC 69) or PC/UMS documentation of total volume (SS) that includes this container as part of the superstructure of the vessel.

If container is securely welded or connected to the deck or to the vessel's structure and the volume of the container is not included in the ITC-69 or SS, the volume of the container will be included as part of the superstructure of the vessel to be reflected in the PC/UMS and if required, an admeasurement service charge will be assessed according to tariff No. 1040.0000. Otherwise, the established Tolls rate is applied, in addition to the applicable per TEU charge. All containers are subject to an inspection and verification by the ACP Admeasurement Unit.

When transported, "Flat Racks" will be considered equivalent to an NTT (Number of TEU Transported) as follows:

- 20' in length is equivalent to a container 20' x 8' x 8.5'
- 40' in length is equivalent to a container 40' x 8' x 9.5'
- 45' in length is equivalent to a container 45' x 8' x 9.5'

In case where "Flat Racks" exceed the dimensions established above, the length and width will be determined and a height of 9.5 feet will be applied. "Flat Racks" will be considered independently, whether loaded or empty. If empty "Flat Rack are stacked on top of each other, the ACP will only charge for one "Flat Rack", provided the height of the stack does not exceed 8.5 feet for a 20' Flat Rack or 9.5 feet for a 40' or 45' Flat Rack, otherwise, additional "Flat Racks" will be charged. On the other hand, when "Flat Racks" are

loaded, and its cargo exceeds 8.5 or 9.5 feet respectively, it will not count as another container.

If bins (standard- size open top containers) are carried on deck to store equipment, each bin will be considered as a container.

When carrying windmill vanes in modified containers, each one of these containers must be declared separately.

Those vessels not classified as container vessels, but that during the transit have containers above the deck, the tolls shall be the product of multiplying its unit of measurement by the corresponding rate established by the Authority plus the NTT (Number of TEUs carried on or above the deck during a transit) multiplied by the corresponding rate per TEU established by the Authority.

It should be noted that information regarding the actual number and size of containers carried on board is critical for the correct application of toll charges to such vessels. Therefore, it is imperative that the information provided to the ACP regarding the actual number and size of containers carried on or above deck is accurate.

As part of routine inspections, ACP boarding officers will review the information provided by the vessel and, if discrepancies concerning the number and/or size of containers on board are detected, a further detailed inspection may be conducted to thoroughly verify the information. Such discrepancies could result in one or more of the following:

- Delay of transit.
- A charge to the vessel for the detailed inspection.
- Assessment of applicable sanctions for violations to provisions of the ACP Regulation on Navigation in Panama Canal Waters.
- Additional security inspection and escort service provided by the ACP Protection and Emergency Response Division charged to vessel.

A Full Container vessel reported as being in a ballast condition, but carrying containers on deck with lashing gears or ship's equipment, will be considered as being in a laden condition.

For toll assessment purposes, a vessel will be deemed in ballast if it is not carrying containers above deck. If it carries containers above deck, the Authority will determine the purpose of the containerized cargo. If such purpose is not commercial, it will be charged the NTT but the ballast condition is maintained. If the purpose of the containerized cargo is commercial, it will be charged the NTT and the tolls shall be charged using the tariff for cargo transported.

13. Deck-loaded Containers on Ships not Built for Container Carriage

a. General

Transits with deck-loaded containers by ships not designed for container trade have become more frequent in recent years. Many of these ships are smaller general purpose, break-bulk, liquid or dry-bulk carriers. When such a ship carries deck-loaded containers well forward or aft of the bridge, the pilot's view can be obstructed, tug and locomotive sound signals can be blanketed, and risk of damage to the ship and Canal structures and equipment is increased. Failure to meet minimum visibility requirements can disrupt overall Canal operations, and can delay the vessel's transit by a day or more.

b. Approval for Transits

In some cases, vessels not meeting minimum visibility requirements may, at the discretion of the Authority, be allowed the instant transit after execution of a proper release that relieves the Authority from liability and indemnifies the Authority for damage or expenses incurred in case of damage of any sort immediately resulting from noncompliance with the visibility requirements. Additional towboats may also be assigned at the vessel's expense. Permanent waivers cannot be granted, and any future transits are expected to be in compliance with visibility requirements.

c. Advance Notice and Inspection

Vessels not container-designed but carrying deck-loaded containers are requested to include in their Canal ETA messages information on the number and location of deck-loaded containers. As a minimum, ships should provide location of deck-loaded containers by hatch or tank; the numbers of containers loaded abeam, fore and aft, and how high they are stacked; and whether containers are oriented athwartships or longitudinally.

Such vessels transiting for the first time, or that only transit occasionally with deck-loaded containers, will be checked by boarding officers or port captains or both to determine the need for visibility waivers.

Such vessels transiting regularly with deck-loaded containers will be advised of any limitations on the number and configuration of deck-loaded containers necessary to satisfy minimum shipboard visibility requirements.

The International Tonnage Certificate 1969 certifying this change must be sent to the Admeasurement Office.

14. Unauthorized Modifications to the ACP/TOLL BASIS Certificate

- a.** Panama Canal Authority boarding officers have reported that some classification societies have made minor corrections to the ACP/TOLL BASIS Certificate for transiting vessels, such as changes in name, call letters, flag; however, the ACP/TOLL BASIS Certificates may only be altered by the Panama Canal Authority.
- b.** The practice of modifying the ACP/TOLL BASIS Certificates, with or without the Classification Society's seal and/or stamp, is unacceptable to the Panama Canal Authority. These unauthorized modifications are grounds for invalidating the vessel's current ACP/TOLL BASIS Certificate and, as a consequence, the Panama Canal Authority must issue a new certificate at the standard re-issue charge (Tariff No. 1040.0200).

15. Calculation of PC/UMS Net Tonnage on Passenger Vessels

- a.** Passenger vessel is a vessel whose main activity is passenger transportation, which is subject to fixed routes and common knowledge. Normally this type of vessel offers accommodations for more than 12 passengers. Those vessels that have been designed exclusively for passenger transportation are eligible for the implementation of a toll per maximum berth capacity (PAX). Berth is a bed or sofa bed to be used by a passenger on a passenger vessel. A bed or a sofa bed that accommodates two people counts as two berths. Those passenger vessels that in addition to passenger carry other cargo, remain under the PC/UMS toll scheme.
- b.** For the purpose of calculating the PC/UMS Net Tonnage of passenger vessels and, thus, assessing tolls in the Panama Canal, passengers and their baggage are considered cargo; therefore, all spaces that have been identified and certified for the use or possible use of passengers are to be included in the total volume calculation of the vessel. Passenger is the one who pays fare. The ballast condition of a vessel is not affected by courtesy passengers.
- c.** For the calculation of the PC/UMS Net Tonnage, the definition of "Excludable Spaces," as provided in Regulation 2, Section 5 of the International Convention on Tonnage Measurement of Ships, 1969 (ITC 69), as well as in the Maritime Regulations for the Operation of the Panama Canal, does not apply to areas on passenger vessels that are for the use of passengers. These spaces, which are designed and certified for the exclusive use of passengers, such as balconies, passageways, swimming pools, etc., are included in the total PC/UMS calculation.
- d.** In addition to the ITC-69 Certificate, passenger vessels shall provide the Panama Canal Authority with a copy of the Passenger Ship Safety Certificate or any document where the maximum berth capacity is documented. It is also recommended to present a copy of the PC/UMS documentation of total volume (Suitable Substitute) that includes the volume of all

enclosed spaces, and also those spaces designed for the use of passengers (as explained in item b), with calculation sheets sufficiently clear in order to facilitate our audit.

e. These documents, as well as the General Arrangement Plan, Capacity Plan with deadweight scale, Midship Section Plan, Lines Plan/Body Plan, Shell Expansion Plan, copy of the International Load Line Certificate, and copy of the Suez Canal Tonnage Certificate, should be submitted to Arqueadores@pancanal.com at least four weeks prior to transit in order to review the calculations and notify the owner or representative of any discrepancies found prior to the vessel's arrival.

16. Dangerous Cargo Requirements

a. General

The Regulation on Navigation in Panama Canal Waters requires a minimum of 96-hour notice of intent to transit with dangerous cargo (*ACP Navigation Regulations, Article 30*). The specific characteristics of the dangerous cargo, whether in bulk or packaged, are the primary factors which determine what, if any, precautionary measures shall be taken by the Authority. Adherence to this requirement will allow the ACP to efficiently assign resources to its operations for the benefit of all customers. Moreover, it ensures appropriate levels of safety for all vessels in transit.

b. Test of Equipment On Board

Vessels carrying dangerous materials are also required to test all dangerous cargo alarms, safety devices, and firefighting equipment as specified in the *ACP Navigation Regulations, Article 115*. An entry shall be made in the ship's log stating that such tests were conducted and that the systems were found in proper working condition or, if not in proper order, a detailed listing of discrepancies shall be included within the log.

c. Holding Due to Non-Compliance

Vessels are also reminded that a dangerous cargo hold ("H") will be imposed on vessels not providing the required advance dangerous cargo information, and that continuing noncompliance will result in not scheduling the vessels for transit. This can result in a delay to the ship.

d. Reporting Dangerous Cargo in Bulk

(1) It is an ACP requirement that all cargo in bulk, either liquefied-gas, liquid or solid be reported in detail via VUMPA no later than 96 hours before ETA. Timely, complete, and accurate information pertaining to the dangerous cargo transported in bulk is of paramount importance to ensure safe operations and efficient vessel scheduling.

(2) Tankers and Liquid Gas Carriers shall submit their stowage plans as well as declare the cargo loading condition of each tank separately, including slop tanks. Specific information required includes the following:

(a) For tanks with cargo (includes slop tanks): Proper shipping name, IMO class, and UN Number of cargo; amount of cargo in metric tons; flashpoint in °C, if applicable; and the condition of the vapor space (inert or not inert).

(b) For empty tanks or tanks containing slops (or residues): Proper shipping name, IMO class, and UN Number of last cargo or residue; amount of residue or slops; flashpoint in °C of last cargo or residue, if applicable; and atmospheric condition of tanks (inert and not gas free; not inert and not gas free; not inert and gas free).

(c) Declarations in 2a and 2b (above) shall be made even if current cargo or last cargo is not listed as dangerous cargo. In such case, the information on proper shipping name, IMO Class, and UN number may be replaced by the Harmonized Commodity Description and Coding System (HS Code) as established by the World Customs Organization (WCO).

(3) All solid bulk cargo carried aboard dry-bulk carriers or general cargo carriers shall also be reported via the Maritime Service Portal. The report shall provide the technical names of the cargo in accordance with the International Maritime Solid Bulk Cargo Code (IMSBC Code).

e. Tankers Claiming Cargo Tanks as "Gas Free"

(1) At the Panama Canal, a vessel's cargo or slop tank is considered to be GAS FREE if it meets the following criteria:

- a. It has been stripped of flammable liquid residues
- b. Its oxygen content is at least 19.5% but not greater than 22% by volume
- c. Its concentration of flammable vapors or gases is less than 10 percent of the Lower Explosive Limit (LEL).

(2) Tankers with all cargo and slop tanks meeting the aforementioned conditions are considered to be GAS FREE. If a tanker is designated as GAS FREE, it may transit without the restrictions applicable to its last cargo.

(3) A note from the Master shall be forwarded to cargoinfo@pancanal.com in order to claim Gas Free status of tanks that previously contained flammable products (i.e. IMO Class 3 cargo).

Note: *The designation as Gas Free shall not be construed as being SAFE FOR ENTRY or SAFE FOR HOTWORK. Section 19 of this Notice outlines the requirements for hot work while in Panama Canal waters.*

f. Reporting Shipments of Direct Reduced Iron

(1) DRI has been classified by IMO as belonging to the "Materials Hazardous only in Bulk, MHB" class and is listed in the International Maritime Solid Bulk Cargo Code (IMSBC Code), Appendix B."

(2) Vessels transporting Direct Reduced Iron (DRI) in any of its forms, hot molded briquettes, cold molded briquettes, lumps, pellets, or by-product fines are required to report the shipment by its Bulk Cargo Shipping Name (BCSN).

(3) When transporting DRI, vessels may be subject to inspection to verify logged and actual temperature, oxygen, and hydrogen readings upon arrival in Canal waters. Furthermore, they shall provide the following information in advance of ETA to cargoinfo@pancanal.com:

(a) Copy of certification that DRI is suitable for loading.

(b) Copy of certification that DRI conforms to IMO requirements.

(c) Statement from master or shipper that IMO precautions as listed in the IMSBC Code have been followed.

(d) Copy of procedures to be followed by the ship's crew to ensure safety of ship and cargo in the event the cargo gets wet.

(e) Copy of Exemption granted by competent authority of the port of loading, if transporting DRI C with moisture content higher than 0.3percent, but lower than 12 percent.

g. *Precautionary Measures Due to Dangerous Cargo*

The precautionary measures assigned by the Authority to vessels with dangerous cargo vary depending on the inherent properties of the cargo and whether it is transported in bulk or packaged. Following is background information on this subject:

(1) Regulations require vessels to communicate detailed information to MTC concerning all dangerous cargo carried no less than 96 hours in advance of arrival.

(2) The Authority boarding officer verifies dangerous cargo information in accordance with Chapter 3 of the Boarding Officer's Handbook.

(3) The Authority's dangerous cargo system uses International Maritime Organization (IMO) classifications that categorize dangerous materials into common groups. For example, gasoline is IMO 3 and LPG is IMO 2.1.

(4) Dangerous cargo information is submitted via VUMPA by the vessel or its representative. Based on this information a single Precaution Designator (PD) is assigned to each vessel by the Transit Operations Division.

(5) The ship will be assigned the PD corresponding to the most restrictive packaged cargo, bulk cargo, empty tank, or slop tank on board.

(6) The PD assigned to each vessel sets forth restrictions and other measures to be taken for that vessel while in Canal Waters.

(7) When a vessel does not provide the necessary information as required by the regulation, an "H" or "HOLD" is assigned. This means that the vessel will not be allowed to transit, dock or enter the Inner Anchorage of Cristobal until the cargo information is made available.

(8) All vessels (public, commercial, private, ACP, etc.) shall have a PD assigned for transiting the locks. All ACP vessels will be assigned a PD N and MTC shall be notified when ACP vessels will have dangerous cargo on board in order to assign the appropriate

PD. A PD N will also be assigned to private yachts, commercial towboats, and fishing vessels under 38 meters (125 feet).

(9) Any vessel which has been assigned a PD from 1 to 6 shall display an identifying flag by day and a red light by night. Flag "B" (BRAVO) indicates flammables or explosives aboard (PDs 1, 3, 4 & 5). Flag "T" (TANGO) indicates toxic or radioactive materials (PDs 2 & 6). Only the general nature of dangerous cargo aboard is thus identified.

h. Reporting Shipments of Hazardous Wastes

Vessels transporting hazardous wastes that are subject to the control of the Basel Convention on their trans-boundary movements and disposal are required to report their shipment to the Panama Canal authorities. The wastes are to be identified by correct technical name, United Nations Number and International Maritime Organization (IMO) Class and Division if applicable.

Additionally, the following advance information should be provided to cargoinfo@pancanal.com

(1) Copy of a movement document, indicating the point at which the trans-boundary movement commences and the point of disposal, name of competent authorities, responsible parties and any other requirements as required by Articles 6, 11 and any other article of the Basel Convention.

(2) Copy of Certification from shipper that the hazardous wastes are packaged and labeled in conformity with applicable IMDG (International Maritime Dangerous Goods Code) requirements.

(3) Statements from Master that the hazardous waste packages are stowed in accordance with applicable IMDG requirements and on his planned response procedures to be followed by the ship to ensure safety of ship and crew in the event the hazardous waste is spilled or leaked.

(4) Proof of financial responsibility and adequate provision for indemnity, consistent with international practice and standards as set forth by the Treaty Concerning the Permanent Neutrality and Operation of the Panama Canal, covering public liability and loss to the Panama Canal Authority and/or any other agency including any possible damage to property and injuries (including death) to persons. Expressly, for every transit with hazardous waste, vessels must submit either one of the following:

(a) A copy of a "coverage in full" certificate issued by any P&I Club. As a minimum, this copy shall allow verification of the issue and expiration dates of the certificate, and shall include the following clauses or provisions:

- Four-fourths (4/4) of the liability arising out of collision with another ship, and
- Liability for loss or damage to any fixed or floating object (FFO).

(b) A copy of the "Hull & Machinery" Policy if it provides the coverage mentioned above.

i. Reporting Radioactive Cargo

(1) The International Atomic Energy Agency (IAEA) is the United Nations Agency authorized by statute to develop and promulgate the **Regulations for the Safe Transport of Radioactive Materials**. These regulations are incorporated into the IMDG Code to establish the requirements for the maritime transportation of radioactive materials.

(2) As such, the Panama Canal Authority requires all vessels transporting radioactive materials through the Panama Canal to comply with applicable requirements as published in the current edition of the IMDG Code.

(3) For additional or specific requirements of any radioactive material shipment, please send request to cargoinfo@pancanal.com

j. Coverage Requirements for Transiting Vessels Carrying Radioactive Cargo

(1) The Panama Canal Authority requires from transiting vessels carrying radioactive cargo, current proof of financial responsibility and adequate provision for indemnity to third parties as a guarantee against any possible damage and/or loss to the Republic of Panama, the Panama Canal Authority, and/or any other agency, including coverage to persons, lives and property.

(2) The aforementioned insurance policies must include the Panama Canal Authority (ACP) as an *Additional Named Assured*. Considering that these insurance policies are for liability coverage, ACP may be regarded as a third party with a right to claim under that policy. As a result, the terms and conditions of the policy must clearly establish that including ACP as an *Additional Named Assured* does not preclude the ACP from presenting a claim under such policy, and does not curtail, in any way, the right of the ACP to be indemnified for any damages that may be suffered.

This requirement is not applicable to insurance policies issued by Protection & Indemnity (P&I) Clubs with respect to excepted materials.

(3) The following requirements of coverage from transiting vessels carrying specific radioactive cargo will apply:

(a) For all radioactive material in excepted packages and non-fissile radioactive material in industrial packages, transiting vessels must provide either:

- A “coverage in full” certificate issued by any P & I Club part of the International Group, including the following provisions:

- Four-fourths (4/4) of the assured (s) liability arising out of collision with another ship, and
- Liability for loss or damage to any fixed or floating object (FFO)

(If the “Hull & Machinery” Policy covers the above, the same must be provided), or

- A minimum amount of US\$20,000,000.00 (twenty million dollars) of liability insurance per TEU container. The Panama Canal Authority may request an increase in the amount of insurance as a result of risk evaluation made by ACP officials.

(b) For fissile radioactive material in industrial packages, and for all fissile and non-fissile radioactive material in Type A, Type B(U), and Type B(M) packages, transiting vessels must provide either:

- A “coverage in full” certificate issued by any P&I Club part of the International Group, including the following provisions:

- Four-fourths (4/4) of the assured (s) liability arising out of collision with another ship, and
- Liability for loss or damage to any fixed or floating object (FFO)

(If the “Hull & Machinery” Policy covers the above, the same must be provided), or

- A minimum amount of US\$30,000,000.00 (thirty million dollars) of liability insurance per TEU container. The Panama Canal Authority may request an increase in the amount of insurance as a result of risk evaluation made by ACP officials.

(c) For radioactive cargo under special arrangement or not consolidated in freight containers or any other radioactive cargo not specifically identified in this Notice, please send note to cargoinfo@pancanal.com

k. Advance Notification of Shipments of Fissile Materials

(1) The ACP requires a 30-day advance notification for vessels that will be transiting the Panama Canal carrying radioactive cargo containing fissile materials.

(2) Vessels in this category must provide, in addition to the 30-day advance notification, full documentation of applicable certificates and technical details of the cargo in order to allow the Panama Canal Authority the opportunity to verify the compliance of the cargo with the IMDG Code. Those vessels that do not comply with the advance submittal of the documentation will not be approved transit through the Panama Canal or may be subject to delays until such time that the documentation review is completed.

(3) For additional details on the required documentation mentioned above, please write to cargoinfo@pancanal.com

l. Tanker Inspection Program

Tankers arriving at Panama Canal waters for transit with toxic and flammable cargo are randomly inspected by the Panama Canal Authority’s (ACP) qualified industrial hygienists/marine chemists to verify they are free of fugitive emissions that could result in harm to ACP personnel and to the general public.

Factors considered when selecting tankers for inspection include: chemical and physical properties of the cargoes, historical performance on previous transits, time elapsed since the last inspection, and the age of the tanker. Preferably, inspections are conducted during daylight hours and at the following anchorages: Atlantic inner, Gatun or Pacific. But if conditions warrant, they can be performed during night time as well as while vessel is underway.

All inspections will target cargo and emission control systems, pump rooms, required flammable and/or toxic fixed and portable detectors, firefighting systems, and other necessary equipment or conditions for a safe transit.

The master or his designee shall escort the inspector throughout the inspections, which will target cargo and emission control systems, pump rooms, required flammable and/or toxic fixed and portable detectors, firefighting systems, and other necessary equipment or conditions for a safe transit.

If cargo vapor leaks are found during these inspections, they will be deemed as deficiencies, and the master will be requested to ensure that corrective actions be swiftly undertaken. Only when all deficiencies are corrected, vessels will be scheduled for transit, or allowed to continue transit if already underway. In the event such deficiencies cannot be corrected, authorization to continue must be given by the Canal Operations Captain or his designee. The tanker may be subject to a re-inspection to verify that proper corrective action was taken.

No fees will apply for the initial inspection, provided no deficiency is found. However, if a deficiency is found, charges for chemist, pilot, and launch services will be invoiced regardless of corrective measures taken. The official tariff is available at <http://www.pancanal.com/eng/maritime/tariff/index.html>

Additional inquiries regarding this process may be directed to cargoinfo@pancanal.com

17. Measures to Prevent Automatic Activation of PV Valves

In order to prevent excessive pressure build up within cargo tanks which could result in the automatic activation of pressure/vacuum (PV) valves during transit, it is required that crude oil tankers, product carriers, and chemical tankers carrying cargoes with flashpoints of less than 18°C, cool their main decks with water by means of the on-deck water sprinkler system, or by using any other means available.

The cooling of the main deck shall be performed between 1000 and 1600 hours while the vessel is underway at Gatun Lake or Gaillard Cut, or at anchor in Canal waters. However, this procedure should be stopped during the transit of the locks, or when Canal deckhands are on board.

If this procedure fails to prevent automatic activation of pressure relief valves, it may be necessary to reduce the pressure by manually opening pressure relief valves. This shall be done only after the master has ascertained the following:

- The situation has been reported to the ACP's Canal Port Captain on duty through the pilot on board, or to the Signal Stations at Flamenco or Cristobal when there is no pilot on board.

- All necessary actions have been implemented to prevent exposing ACP personnel to vapors.
- Shipboard and nearby ignition sources have been controlled.

Compliance with measures described above will enhance the safety of Canal operations, as well as Canal customers, and reduce or eliminate possible disruptions in transit scheduling.

For further information, please direct your inquiries to cargoinfo@pancanal.com

18. Pre-arrival Cargo Declaration, Security Inspection and Escort

a. Vessels intending to arrive at Panama Canal waters must declare all cargo carried on board at least 96 hours prior to their arrival. Vessels that arrive from ports that are less than 96 hours away are required to submit revisions to their original cargo declarations as may be necessary in order to provide updated cargo information. Exceptions to this requirement are:

- Bins (standard-size open top containers) or any other receptacles (not containers) that are carried on deck to store equipment that is not welded or spot welded. The vessel's master must declare the information regarding these items to ACP boarding officers upon arrival at Panama Canal waters.

- Vessels intending to transit transporting fissile radioactive material, as defined in the IAEA's Regulations for the Safe Transport of Radioactive Material, shall provide 30 day advance notification.

ACP boarding officers will verify cargo information submitted in the pre-arrival notification and discrepancies with the cargo manifest presented by the master will be reported to the ACP Protection and Emergency Response Division. These discrepancies will be evaluated and may lead to the application of security control measures as deemed necessary by the ACP. These control measures may include, but not be limited to one or more of the following:

- Direct communication with the vessel's master to clarify any discrepancies or any other security related issues,
 - Delay of transit,
 - The assignment of additional resources,
 - The escorting of the vessel,
 - Fines

All additional resources provided by the Canal on account of discrepancies identified during the verification of the cargo declaration will be charged to the vessel. Notwithstanding the above, the discrepancies detected shall be corrected and submitted

through the Maritime Service Portal before the vessel departs to sea. Failure to do so may result in a notification being sent to the Port Facility Officer of the next port of call, as well as in an increase to the vessel's assigned security level the next time the vessel is presented for transit.

b. The ACP will provide additional security inspection and escort services to vessels that fail to comply with the 96-hour pre-arrival notice, or that submit their pre-arrival notice with wrong or missing information. The Canal Protection Inspection and Escort Tariff will be applied as follows:

- A vessel inspection may be triggered due to:
 - 96-hour regulations non-compliance;
 - Incorrect or missing information in Ship Due, Crew List or Passenger List; and
 - Requirement by Panamanian authorities.

An escort may be triggered at any moment after a Canal Protection Inspection, if the inspection corroborates the non-compliance with ACP security and protection regulations.

The ACP will continue to verify the cargo declaration submitted in the Maritime Service Portal and the cargo manifest provided by the master. If discrepancies are detected, the vessel's operator and/or shipping agent will be contacted to coordinate the correction of the submitted data. This data shall be corrected within 96 hours from the time the discrepancies are detected and reported. The following information is to be verified:

- The total weight of cargo on board declared on the Ship Information and Quarantine declaration will be compared with the weight declared on the Maritime Service Portal. A percentage of tolerance and tare weights will be applied to offset differences due to diverse information origin (including departure from ports within 96 hours to Panama Canal Waters) and container weight.
- Total container units on board. For vessels with cargo movements after boarding inspection, the Master will declare amount of containers to be loaded and discharged.

If the information is not corrected during the provided time period, a report will be filed to ACP Protection and Emergency Response Division in order to be included in the risk assessment matrix for that vessel. This could lead into a safety or security inspection and/or escort of the vessel during her next transit.

19. Hot Work Performed On Board Vessels

a. Applicability: These requirements apply to hot work on board the following vessels while in Panama Canal waters, which includes anchorages and marine terminals: tankers, and vessels other than tankers that have carried liquefied gas, or flammable liquid, or combustible liquid in bulk as fuel or cargo, or that have carried cargoes that can produce hazardous atmospheres.

b. Definitions: The following definitions apply:

1. **Hot Work:** any type of work that involves open flames, generates sparks, or rises the temperature of the intervened materials. Some examples are welding, grinding, drilling, and cutting.
2. **Marine Chemist:** A chemist with the professional and practical qualifications to determine if hot work can be safely performed on board ships. The Marine Chemist shall be from an organization compliant with DGNTI-COPANIT ISO 17020; hence, independent of the vessel, of the party performing the hot work, and of the Panama Canal.
3. **Competent Person:** An employee of a shipyard or ship repair company with knowledge and training similar to a Marine Chemist with respect to hot work on board ships. The Competent Person is responsible for verifying that the conditions set forth on the Marine Chemist Certificate are maintained, and for contacting the Marine Chemist should these conditions change at any time prior to or during the work.
4. **Marine Chemist Certificate:** A document issued by a Marine Chemist that describes the areas verified, the tests performed, and the standard safety designations for the hot work to be performed.
5. **Exemption Certificate:** A certificate issued by a Marine Chemist indicating the areas on board a ship where routine hot work can be performed without the need of a Marine Chemist Certificate. The exemption certificate is issued after an inspection by the Marine Chemist in order to confirm that areas included in the certificate are not confined spaces, void spaces, or do not pose a risk of accumulating flammable or toxic gases prior to or during hot work.
6. **Confined Space:** A space with no natural ventilation and with restricted entry and exit, but large enough for a person to enter in order to perform work. This space is not designed to be continuously occupied and may exhibit one or more of the following characteristics: a dangerous atmosphere, a material or design (sloping floor) that can entrap a person, or any other recognized danger that may hinder health or safety.
7. **Tanker:** A ship built or modified for the transport of liquids or liquefied gases in bulk. The products transported on these vessels are regulated under MARPOL Annex I, the IBC Code, or the IGC Code.
8. **Flammable Liquid:** A liquid with a closed-cup flashpoint at or below 60 °C.
9. **Combustible Liquid:** A liquid with a closed-cup flashpoint above 60 °C.

c. Prohibitions. The following actions are prohibited:

- (1) Submittal of a Marine Chemist Certificate from an organization not compliant with DGNTI-COPANIT ISO 17020.
- (2) Commencing hot work without receiving a worksite authorization from the ACP.
- (3) Hot work beyond the scope described on the Marine Chemist Certificate.
- (4) Hot work on a vessel that has been moved after the inspection, even if its trajectory brings it back to the original site of the inspection.
- (5) Hot work on board flammable cryogenic liquid carriers, unless it is required under specific circumstances (i.e. for Canal operations or due to an incident while under Panama Canal pilotage).

d. In order to ensure safe conditions, before any hot work is performed in fuel tanks, cargo tanks, void spaces, hydraulic pipes, fuel pipes, accommodations, or any other hollow structure on board ships in Canal waters that could result in a fire or an explosion due to the accumulation of flammable gases or vapors, a written request for authorization of the site where the ship is located, accompanied by a Marine Chemist Certificate approving the intended hot work, shall be forwarded by email to the Canal Port Captain Office, Balboa at ntos-cp1@pancanal.com, or Cristobal at nton-cp1@pancanal.com, as well as to cargoinfo@pancanal.com

e. Notwithstanding the above, the requester may apply for an Exemption Certificate for following specific instances:

1. Shiplide Spaces // deck of workboats // flat barge:
 - i. It maintains an oxygen supply between 19.5% and 22.0% by volume.
 - ii. It is not subject to the presence or accumulation of flammable, combustible, or toxic liquids, vapors, or gases.
 - iii. It is not adjacent to spaces or tanks that do require a Marine Chemist's Certificate.
2. Shiplide Structures:
 - i. The structure is not subject to the accumulation of flammable, combustible, or toxic liquids, vapors, or gases.
 - ii. It is not adjacent to spaces or tanks that do require a Marine Chemist's Certificate.
3. Off-the-Vessel Structures (chains, anchors, etc.):
 - i. The structure is not subject to the accumulation of flammable, combustible, or toxic liquids, vapors, or gases.

This Exemption Certificate shall be issued by a Marine Chemist and forwarded to the email addresses listed above in paragraph d, and will be valid for 30 days or until the work has been completed, whichever is less.

f. For the ACP to consider requests for authorization of the worksite, the Marine Chemist Certificate shall be legible and shall include minimally the following:

1. A unique numeric or alphanumeric identifier for the Certificate.
2. Name, SIN and/or IMO numbers of the vessel.
3. Type of vessel.
4. Vessel's owner, agent, or responsible party.
5. Requester's name, telephone number, and email address.
6. Vessel's actual location. The vessel must not be moved after the inspection.
7. A description or sketch of the scope of work to be performed.
8. Results of tests performed to determine the atmosphere within the relevant void space, hollow structure, confined space, and/or adjacent space. As a minimum, measurements of oxygen, combustible, and toxic gases shall be reported for each space.

9. Date and time inspection was completed.
 10. Frequency of required re-inspections by a Competent Person.
 11. Conditions under which the Marine Chemist shall be consulted or recalled.
 12. Any additional requirements, limitations or restrictions, such as fire watch, ventilation, or lock out & tag out, if any.
 13. The applicable NFPA 306 Standard Safety Designation(s).
 14. The Marine Chemist's name, signature, and license number.
 15. Signature for receipt of the Marine Chemist Certificate by the requester or authorized representative, signifying the understanding of the conditions, and the limitations and requirements for maintaining conditions under which it is issued.
- g.** The ACP will reject requests if the Marine Chemist Certificate does not comply with the above.
- h.** The Marine Chemist Certificate may remain valid until the completion of the work to be performed or until any of the original conditions changes, whichever occurs first.
- i.** The Competent Person must re-inspect worksite conditions and report to the Marine Chemist at a frequency established by the Marine Chemist. The ACP will randomly request proof of this reporting to either or both parties. If parties fail to provide evidence of compliance with this requirement, the ACP will void the authorization and the hot work will be stopped until the deficiencies are corrected to the satisfaction of the ACP.
- j.** The Marine Chemist Certificate approving the hot work, as well as the authorization of worksite issued by the ACP, shall be securely posted in a conspicuous location aboard the vessel prior to the work commencing.
- k.** The authorization of the worksite shall not be construed as an endorsement by the ACP of the Marine Chemist Certificate.
- l.** Failure to comply with these requirements may result in one or more of the following:
1. Invalidation of approved worksites
 2. Non-approval of worksites
 3. Sanctions
 4. Fines

20. Manning Requirements

Vessel agents and their principals should remind ships' personnel that sufficient personnel must be available for a safe operation while in Canal waters. The Transit Operations Division Executive Manager, or his designee may deny transit if, in his opinion, the vessel is insufficiently manned. These requirements include:

- (1) At all times while underway in the Canal and adjacent waters, vessels should maintain a proper lookout with no other assigned duties.
- (2) A full watch on deck and in the engine room while underway in Canal waters.

(3) At least one officer and two seamen forward and aft respectively to handle lines and machinery (winches) expeditiously when approaching a lock, while moored temporarily to a lock wall, when entering, in or leaving a lock chamber, or when docking, undocking, or mooring to a tie-up station, or to receive and let go tug lines, or when so requested by the pilot.

(4) When a vessel is entering or leaving a lock, getting underway, berthing, shifting berth, anchoring, or is underway in Gaillard Cut, the master shall be on the bridge and all other officers shall be at their regular stations.

(5) As otherwise required by the *ACP Navigation Regulations, Articles 102 to 106*.

(6) Should Canal officials or the vessel's agent require the master's presence or attention, the request may be granted by the pilot provided the master's presence is not momentarily essential and a qualified representative remains on the bridge. The master shall remain or return to the bridge at the pilot's request.

21. Additional Pilots due to Vessel Deficiencies

a. Some vessels arriving for transit with certain noted deficiencies or conditions require the assignment of additional pilots in order to allow them to safely complete their transit.

Any vessel that requires the assignment of pilots in addition to the number of pilots normally required by a vessel of her size will be assessed additional pilotage fees in accordance with established tariffs:

- Pilots assigned before transit begins.
- Pilots assigned due to late discovery of deficiency.

Some deficiencies or conditions that could require additional pilots are:

- Restricted visibility
- Inadequate sanitary facilities
- Inability to relay
- Vessel Configuration
- Inability to develop and maintain the minimum *full ahead* speed required to complete the transit in standard times.

b. In addition, small craft (handlines) using transit advisors instead of pilots, which are unable to complete their transit on the same day, are assessed the tariff for transit delay for the additional transit advisor at the rate specified in Tariff 1060.0023.

Whenever small craft (handlines) present some deficiency or condition that prevent the completion of their transit as scheduled, they are assessed the tariff for transit delay (Tariff 1060.0023) and other related charges, such as launch and moorage.

Whenever owners or representatives of small craft (handlines) request to stop in the Canal interrupting their transit, they are assessed the tariff for transit delay (Tariff 1060.0023) and other related charges, such as launch and moorage. However, if a transit is interrupted due to Canal scheduling considerations, these charges will not be applied.

22. Pilot Accommodations On Board Transiting Vessels

Although the majority of transiting vessels provide Panama Canal pilots with adequate accommodations, some masters are still reluctant to comply with this requirement.

Sometimes pilots are required to stay on board while not actually engaged in piloting duties; therefore, they shall be provided with a cabin that is clean, serviceable, darkened and equivalent to an officer's cabin. These cabins should have a private working toilet facility.

23. Air Conditioning Systems on Transiting Vessels

Vessels designed to operate with functioning air conditioning systems have been arriving for transit with their air conditioning systems disabled or not available for use. Due to high temperatures and humidity prevalent in Panama, personnel required to work onboard these vessels during transit are adversely affected by the failure of this equipment.

Vessels equipped with wheelhouses with sealed windows that cannot be opened for ventilation, must be equipped with a properly working air conditioning system or units that provide an adequate environment for pilots.

The air conditioning system is part of the vessel's equipment, and as such, should be available for use during transit. Consequently, when the air conditioning system fails, forced ventilation fans must be made available.

Additionally, the same controlled environment shall be offered for pilot accommodations, as indicated in Section 22 of this Notice.

24. Main Source of Electrical Power

a. The main source of electrical power shall have sufficient capacity to supply all essential and auxiliary services necessary for maintaining transiting vessels in normal operational and habitable conditions without recourse to the emergency source of electrical power.

b. This main source of electrical power shall consist of at least two generating sets. The capacity of these generating sets shall be such that in the event of any one generating set being stopped it will still be possible to supply those services necessary to provide normal operational conditions of propulsion and safety.

c. In compliance with SOLAS requirements, the generating sets shall also supply the power to enable minimum comfortable conditions of habitability, which include adequate services for cooking, heating, domestic refrigeration, mechanical ventilation, sanitary and fresh water.

25. Emergency Source of Electrical Power

- a. A self-contained emergency source of electrical power shall be provided. This emergency source of electrical power may be either a generator or an accumulator battery.
- b. The electrical power available shall be sufficient to supply all those services that are essential for safety in an emergency, due regard being paid to such services that may have to be operated simultaneously.
- c. Where the emergency source of electrical power is a diesel generator set, it shall be provided with enough fuel oil for at least 18 hours of continuous operation.

26. Sanitary Facilities and Sewage Handling

- a. Vessels transiting the Canal should have available for the pilot(s) a suitable sanitary facilities. The facilities should have a “Western-style” toilet equipped with a seat. This is particularly important for barges, small craft (handlines) and other vessels which are not normally so equipped and whose progress is slow. Vessel shall also have “Western-style” sanitary facilities for the intended use of the Canal deckhands on deck or close to their working areas, and must be in suitable sanitary conditions. In case there are no sanitary facilities close to the deckhands working area, or the existing ones are kept in poor conditions, vessel shall make proper arrangements to provide one, in good conditions, when requested.
- b. If a transiting ship does not have adequate sanitary facilities, the interval for which each pilot is assigned will be shortened, and significant delays could result.
- c. Discharge of sewage is strictly prohibited. Water bodies under the responsibility of the Panama Canal Authority are **NO-DISCHARGE Zones** for treated or untreated sewage. The Gatun Lake is a drinking water intake zone.
- d. When a sewage treatment plant is used, the treated sewage must be collected in a holding tank with capacity for the retention of all treated sewage while the vessel remains in Canal waters.
- e. Sewage overboard discharge valves must be clearly marked, closed and secured by padlocks or other approved method when ships enter the Panama Canal Pacific Anchorage or Atlantic Anchorage areas, and must remain in that condition until vessel departs from Panama Canal waters. The outer boundaries of Canal waters are those of the Pacific and Atlantic anchorage areas, as indicated in nautical charts DMA No.21603 and DMA No.26068 respectively.

<

27. Ballast Water Management

- a. Discharge of ballast water, managed and unmanaged, is strictly prohibited from the southern ends of Miraflores and Cocoli locks to the northern ends of Gatun and Agua Clara locks.

- b. At least two (2) hours prior to the scheduled pilot time for the vessel's Canal transit, ballast water overboard discharge valves must be closed and secured by padlocks or other approved method, and must remain in that condition until vessel completes the Canal transit.
- c. Vessels that arrive to the Atlantic or Pacific anchorage areas are strongly encourage to manage their ballast water to prevent the discharge of high risk ballast. Discharge of unmanaged ballast water is prohibited in these areas.
- d. Vessels arriving to either the Pacific or Atlantic port terminals to undertake cargo loading/BW discharging operations, shall be fitted with an approved and operational Ballast Water Management System (BWMS). In cases where the vessel is not fitted with an approved BWMS, it may commence cargo loading operations; however it would not be allowed to discharge ballast water. If the vessel is unable to complete its cargo loading operations without discharging ballast water, it would be required to cease cargo loading.
- e. Ballast water taken up and discharged in the same place is considered low risk, provided that the water comprises 95 percent or greater of the volume of water in the tank. At the Pacific side of the Panama Canal, the same place is considered to be the waters within the Port of Vacamonte, the islands of Melones, Taboga, Taboguilla, the eastern boundaries of the Pacific Merchant anchorage and the Balboa basin. At the Atlantic side of the Canal, the same place is considered as waters within the boundaries of the Outer Atlantic anchorage and the northern ends of Agua Clara and Gatun locks.
- f. Vessels that only uptake and discharge ballast water in the same place are not required to meet the Regulation D2 (Treatment Discharge Standard), and therefore are not required to have an IMO type-approved BWMS
- g. Vessels will only maintain the low-risk ballast water condition if they operate within the "same place". However, if these vessels are relocated from the Pacific to the Atlantic side or from the Atlantic to the Pacific side of the Canal with ballast water within their tanks, the same place condition for the ballast water is void. Consequently, their ballast water will be considered high risk to their new location and shall not be discharged until properly managed as per the vessel's BWMP.
- h. Disposal of tank sediment is strictly prohibited in water bodies under the responsibility of the Panama Canal. Eductors are not permitted to strip ballast tanks, unless a vessel seeks permission from the Canal Port Captain to discharge sediment to a reception facility.
- i. The Ballast Water Record Book (BWRB) and the Ballast Water Management Plan (BWMP) shall be available for inspection by the Panama Canal authorities on request.

28. Discharging of Vessel Wastes, Oily Bilge Water and Ballast Water

In compliance with ACP Sanitation Regulations, Article 40:

- (1) Vessels shall not discharge or throw into Panama Canal waters any ballast, ashes, boxes, barrels, straw, paper or other solid matter, including garbage; nor discharge heavy

slops, engine or fire room bilge water, oil, radioactive substances, or any other contaminating substances.

(2) Before arrival at a port in Canal waters, vessels shall dispose of all waste in a manner consistent with the requirements of the International Convention for the Prevention of Pollution from Ships 73/78 (MARPOL) and all amendments thereto. If unable to dispose of waste at sea, vessels may use the services available for such purpose.

(3) Incineration of wastes on board ships is specifically prohibited in Canal waters, in compliance with MARPOL, Article 5 of the 1996 Protocol.

(4) Heating of contents in the sludge tanks is prohibited from two hours prior to the pilot boarding time and during the entire transit.

(5) Residues from the Exhaust Gas Cleaning System (EGCS) washwater are to be collected on board. Discharging these residues into the water bodies under the responsibility of the Panama Canal or incinerating them on board is not permitted.

(6) If a Closed Loop Scrubber system is operated during Canal transit, the cleaned bleed-off water is to be retained in a holding tank on board.

29. Emergency Escape Breathing Devices

a. The minimum number of Emergency Escape Breathing Devices (EEBD) to be kept within accommodation spaces should be as follows:

(1) For cargo ships: two (2) EEBDs and one (1) spare EEBD;

(2) For passenger ships carrying not more than 36 passengers: two (2) EEBDs for each main vertical zone and a total of two (2) spare EEBDs; and

(3) For passenger ships carrying more than 36 passengers: four (4) EEBDs for each main vertical zone and a total of two (2) spare EEBDs.

b. In machinery spaces for category A vessels containing internal combustion machinery used for main propulsion, EEBDs should be positioned as follows:

(1) One (1) EEBD in the engine control room, if located within the machinery space;

(2) One (1) EEBD in workshop areas. However, if there is a direct access to an escape way from the workshop, an EEBD is not required; and

(3) One (1) EEBD on each deck or platform level near the escape ladder constituting the second means of escape from machinery space (the other means being an enclosed escape trunk or watertight door at the lower level of the space.)

b. For machinery spaces of category A vessels other than those containing internal combustion machinery used for main propulsion, one (1) EEBD should, as a minimum, be provided on each deck or platform level near the escape ladder.

30. Smoking Prohibition in Canal Waters

Pursuant to the Regulation on Sanitation and Communicable Disease Prevention, the ACP has prohibited smoking in enclosed areas on vessels in Panama Canal waters in the presence of ACP officials performing their duties.

The ACP has adopted general provisions of the National Health Authority and recommendations of the World Health Organization (WHO), as well as those deriving from international conventions to which Panama is a party, in order to ensure the health and safety of the employees of the ACP.

31. Maneuvering Fuel

a. Except as specified below, vessels arriving at Panama Canal (ACP) waters shall switch their main propulsion engines, boilers, auxiliary generator engines, and other ancillary equipment from residual fuels to marine distillate fuels. Panama Canal waters consist of its fresh water reservoirs and the Pacific and Atlantic Anchorage areas, as outlined in Nautical Charts DMA No. 21603 and DMA No. 26068, respectively.

b. Vessels shall record the fuel changeover in their Engine Room Logbook and/or Fuel Oil Changeover Record Book. The record book entries shall specify the date and time of commencement and ending of the changeover from marine residual fuel to marine distillate fuel.

c. After completion of any changeover to marine distillate fuel, the vessel shall verify that the main propulsion engine operates properly. If necessary, the vessel shall undertake appropriate corrective actions to ensure the vessel's safe and expeditious transit of the Panama Canal.

d. Vessels may supplement or replace marine distillate fuels with any of the following:

1. LNG fuel (including boil-off gas)
2. Biofuels compliant with MARPOL Annex VI
3. ULSFO or VLSFO not exceeding a viscosity of 70 centistokes @ 50°C. These vessels shall submit to the ACP for evaluation, at least 96 hours prior to ETA at Panama Canal waters, copy of the corresponding bunker delivery note.
4. A closed loop scrubber in zero discharge mode or a hybrid scrubber in closed loop and zero discharge mode

e. Vessels opting to use closed loop scrubbers or hybrid scrubbers in closed loop and zero discharge mode, shall submit the following to the ACP for evaluation, at least 96 hours prior to ETA at Panama Canal waters:

1. Copy of the Supplement to the IAPP Certificate
2. Total volume of effluent holding tanks. Effluent holding tanks shall be empty upon arrival at Panama Canal waters.
3. Copy of the bunker delivery note corresponding to the high Sulphur fuel oil (HSFO) in use.

- f.** The use of open loop scrubbers or hybrid scrubbers in open loop mode is prohibited in Panama Canal waters.
- g.** Vessels making only a local port call and not transiting will not be required to switch to marine distillate fuel. These vessels may use a marine residual fuel with a maximum sulphur content of 0.5% or a closed loop scrubber or hybrid scrubber in closed loop and zero discharge mode.
- h.** Vessels anchoring prior to transit will be permitted to use marine residual fuel with a maximum sulphur content of 0.5% to operate their auxiliary generator engines, boilers, and other ancillary equipment while at the Pacific or Atlantic Anchorages, only if they are capable of maintaining their main propulsion engines simultaneously on marine distillate fuel.
- i.** The vessels described in the preceding paragraph shall switch from the fuel being used for their auxiliary generators, boilers, and other ancillary equipment to marine distillate fuel at least two (2) hours prior to the scheduled pilot time for their Canal transit. These vessels will be deemed ready for transit only after the changeover to marine distillate fuel has been completed.
- j.** Vessels proceeding to port terminals or anchorages within Canal waters immediately after completing their transit will be permitted to switch back to residual marine fuel with a maximum sulphur content of 0.5%, once the vessel is moored alongside the dock or is anchored.
- k.** Further inquiries on the subject matter shall be directed to: fuel-compliance@pancanal.com

32. Proper Display of the Panamanian Flag

The Panama Canal Authority Regulation on Navigation in Panama Canal Waters, Article 26, Section Four, Chapter I, Requirements and prohibitions, states that “All vessels shall display the Panamanian flag from dawn to 1800 hours while they are in Panama Canal waters, and may also display their national and house flags.”

The following information governs the proper manner in which to display the Panamanian flag on vessels while in Panama Canal waters, including its anchorages.

The Panamanian flag is divided into four rectangles of equal size. The top two quadrants are white with a five point blue star in the center on the hoist side and plain red. The bottom two quadrants are plain blue on the hoist side and white with a five point red star in the center.

The flag must be displayed with the white quadrant with the blue star on top, adjacent to the flagpole, leaving the blue quadrant directly below and also adjacent to the flagpole.

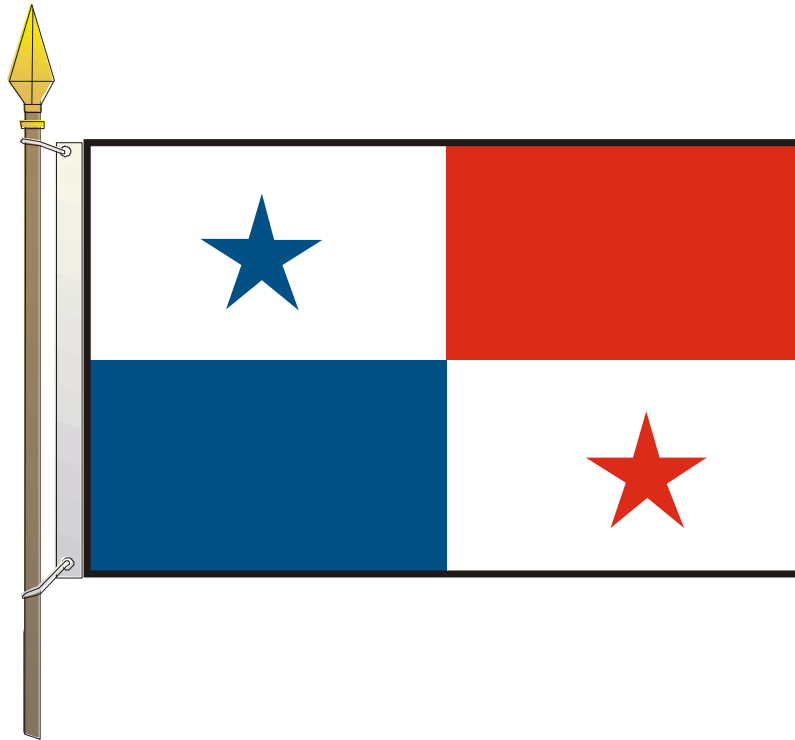

33. Use of Drones in the Panama Canal

The Panama Canal Authority (ACP) is aware of the significant improvements on the design and capabilities of unmanned aerial vehicles (drones). However, due to the inherent risks posed by their utilization, and in order to safeguard the privacy, safety and security of its customers and operations, the ACP hereby announces that the utilization of drones of any kind in Panama Canal waters and operational areas, such as the locks, anchorages, navigation channels and shore installations, is restricted.

Only drones owned and operated by the Panama Canal Authority on official assignment are authorized to be operated in areas under its jurisdiction.

ANNEX 1

Panamax Locks Composite Maximum Clearances

GENERAL NOTES

1. SEVERAL MISC. PORTABLE STRUCTURES (SUCH AS PERSONNEL, SHUTTERS, WATER COOLER BENCH, HANDRAILS, VENTILATOR HOODS, ETC.) ARE OBSTRUCTING ON SIDEWALLS. THESE CAN BE READILY REMOVED.
2. LAMP STANDARDS CAN BE LOWERED OR REMOVED READILY.
3. DASH LINES INDICATE VERTICAL OBSTRUCTION VARIATIONS DUE TO CHANGES IN TIDE AND/OR WATER LEVEL.
4. RANGE TOWER AT GATUN IS 22.0 FROM FACE OF WEST LOCK WALL. VERTICAL CLEARANCE REQD. = 36.37.

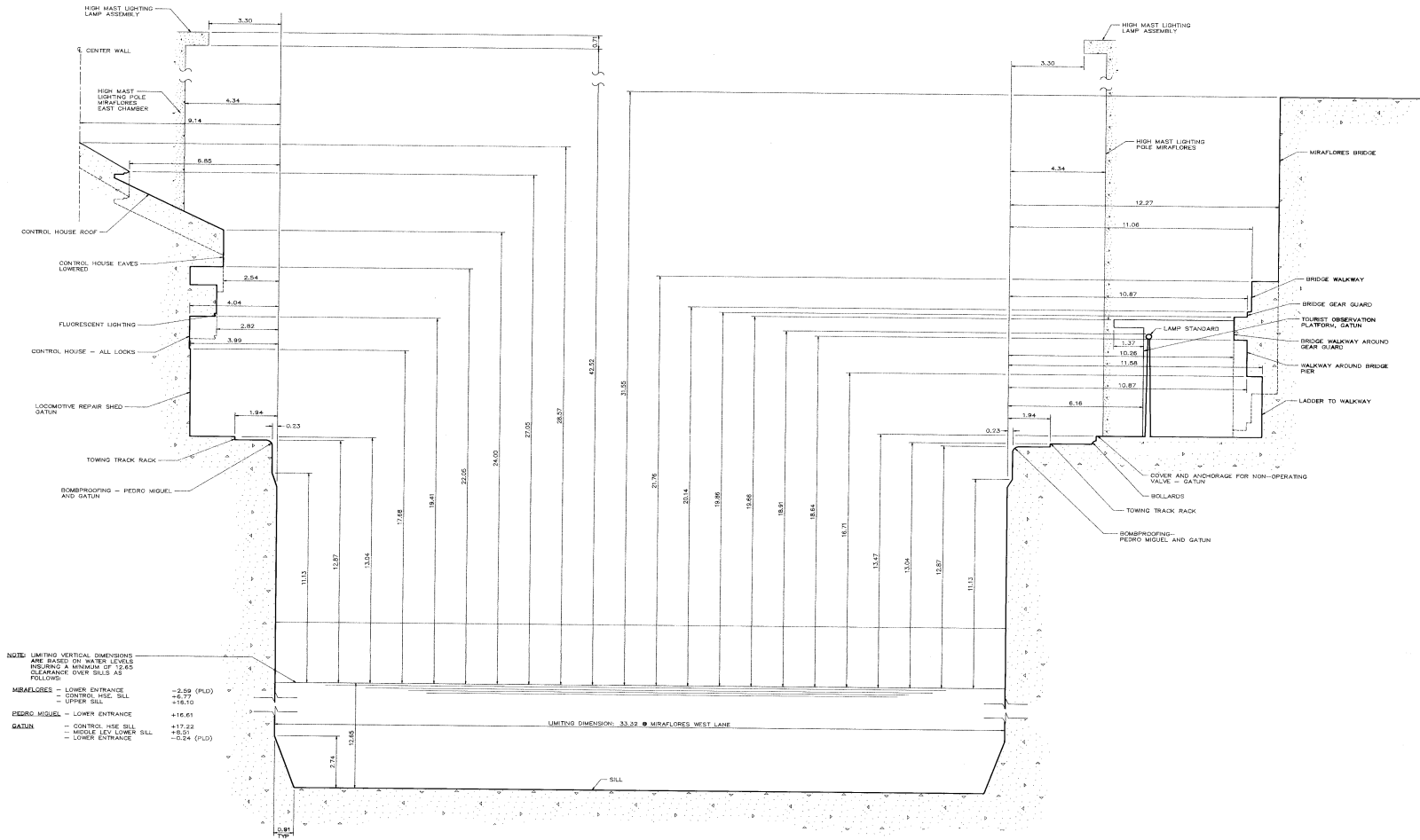

NOTE: LIMITING VERTICAL DIMENSIONS ARE BASED ON WATER LEVELS INSURING A MINIMUM OF 12.65 CLEARANCE OVER SILLS AS FOLLOWS:

MIRAFLORES - LOWER ENTRANCE	-2.09 (PLD)
- CONTROL HSE. SILL	-2.27
- UPPER SILL	+13.70
PEDRO MIGUEL - LOWER ENTRANCE	+16.61
GATUN - CONTROL HSE. SILL	+17.22
- MIRAFLORES LOWER SILL	+18.07
- LOWER ENTRANCE	+22.24 (PLD)

DIMENSIONS IN METRIC SYSTEM

SUPERSEDS SAME DWG. 5044-424, DATED 10-17-63

JOB SAFETY DEPENDS ON YOU

PANAMA CANAL COMMISSION	
ENGINEERING AND CONSTRUCTION BUREAU	
DESIGNING DIVISION	
BALBOA HEADQUARTERS, REPUBLIC OF PANAMA	
ALL LOCKS	
COMPOSITE MAXIMUM CLEARANCES	
ALL LOCKS	
LIMITING DIMENSIONS	
GENERAL NOTES AND SECTION.	
SCALE: 1:75	DATE: AUGUST 28, 1991
DESIGNED: ROY / LB	SUBMITTED: [Signature]
DRAWN: R. HAWKINS, JR.	CHECKED: [Signature]
APPROVED: [Signature]	APPROVED: [Signature]

5044-424 SHEET 1 OF 2

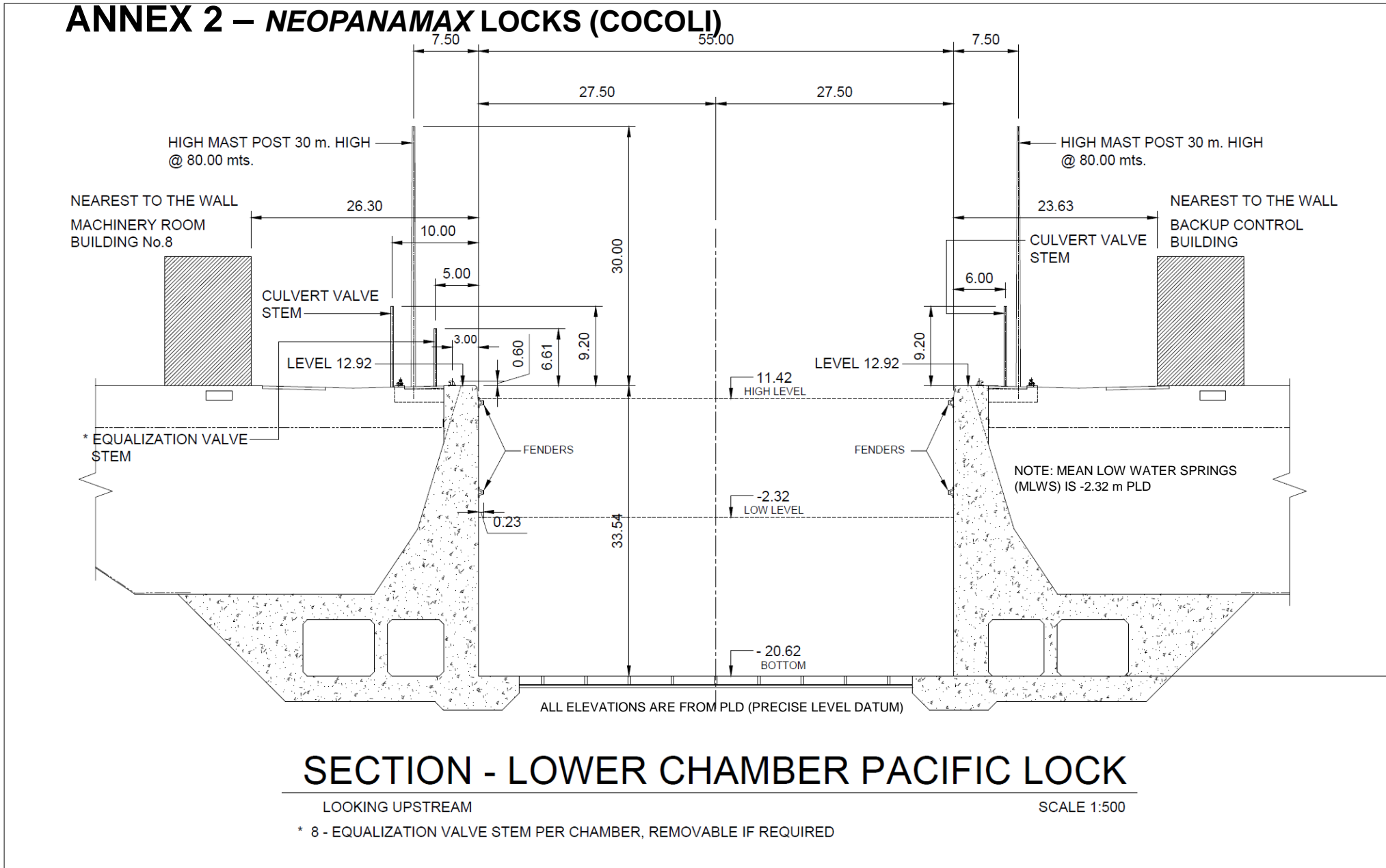

ANNEX 3 – NEOPANAMAX LOCKS (AGUA CLARA)

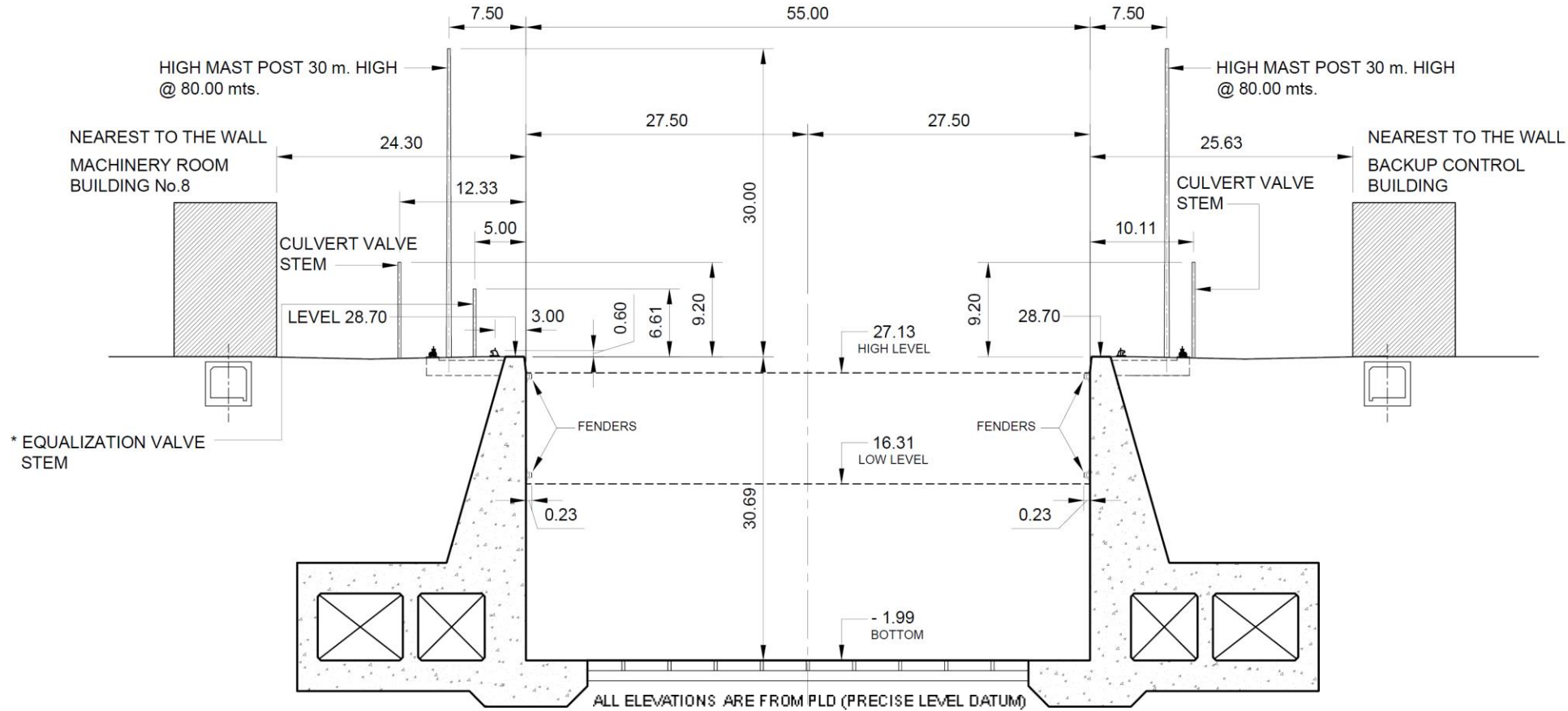

SECTION - UPPER CHAMBER ATLANTIC LOCK

LOOKING UPSTREAM

SCALE 1:500

* 8 - EQUALIZATION VALVE STEM PER CHAMBER, REMOVABLE IF REQUIRED

ANNEX 4 – NEOPANAMAX LOCKS CLEARANCES

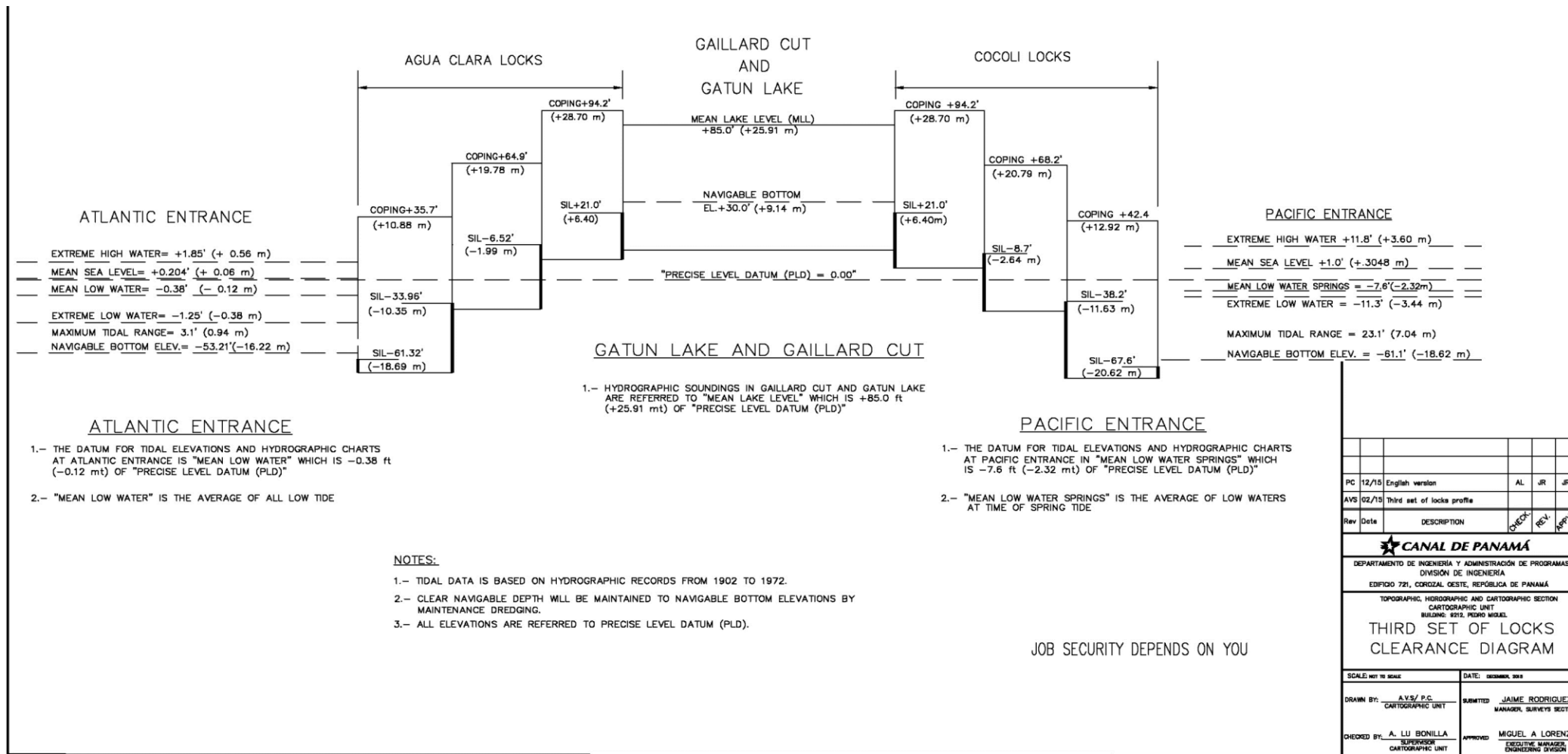

M 6120-30 D (ENGLISH)